

Tucson Amateur Packet Radio

PSK Modem Kit

Rev C

Copyright (c) 1990
Tucson Amateur Packet Radio Corporation
P.O. Box 12925
Tucson AZ 85732
(602) 749-9479

All rights reserved.

Reproduction or translation of any part of this work beyond that permitted by Sections 107 or 108 of the 1976 United States Copyright Act (or its legal successor) without the express written permission of Tucson Amateur Packet Radio Corporation is unlawful except as noted below. Requests for permission to copy or for further information should be addressed to Tucson Amateur Packet Radio Corporation.

Except as noted above, permission is hereby granted to any non-profit group or individual to reproduce any portion of this document provided that: the reproduction is not sold for profit; the intent of the reproduction is to further disseminate information on Amateur packet radio; the reproduction is not used for advertising or otherwise promoting any specific commercial product; full credit is given to Tucson Amateur Packet Radio Corporation (including address) as the original source of information; and Tucson Amateur Packet Radio Corporation is notified in writing of the reproduction.

March 1990

SECOND EDITION

1990

The information contained in this document has been carefully checked and is believed to be entirely reliable. However, no responsibility is assumed for inaccuracies. Tucson Amateur Packet Radio Corporation (TAPR) reserves the right to make changes in any products to improve reliability, function or design without obligation to purchasers of previous equipment. TAPR does not assume any liability arising out of the application or use of any product or circuit described herein; neither does it convey any license under its patent rights or the rights of others.

First Printing - March, 1990

ACKNOWLEDGEMENTS

The Tucson Amateur Packet Radio (TAPR) PSK Modem project was made possible by the active participation of a number of Amateur radio operators and organizations worldwide. While the following list is by no means complete, TAPR wishes to acknowledge their contribution to this project.

Individuals

Mike Brock, WB6HHV
Tom Clark, W3IWI
Jack Davis, WA4EJR
Chuck Green, N0ADI
Eric Gustafson, N7CL
Lyle Johnson, WA7GXD
Tom King, KA6SOX
Dan Morrison, KV7B
Tak Okamoto, N6MBM/JA2PKI
Michael Rice, KL7YV

...and the builders of the PSK modem since 1987 whose feedback made this improved version of the manual possible.

Organizations

AMSAT - Amateur Radio Satellite Corporation
ARRL - American Radio Relay League
JAMSAT - Japan Amateur Satellite
JARL - Japan Amateur Radio League

Table of Contents

INTRODUCTION	1
PARTS LIST	2
Capacitors	2
Diodes	2
Resistors	2
Trimpots	3
Integrated Circuits	3
Voltage Regulators	3
Connectors	4
IC Sockets	4
Switches	4
Miscellaneous	4
Packed Separately	4
CONSTRUCTION	5
Display Board	6
Main Board	9
IC Sockets	9
Resistors	10
Capacitors	12
Diodes	14
Trimpots	15
DIN Connectors	15
Voltage Regulators	15
Headers	15
Preliminary Checkout	16
IC Installation	17
Static Precautions	17
6-Conductor Cable	18
Preparation	18
Display Board Termination	19
Main Board Termination	19
Front Panel Wiring	20
S1 - Receive Mode	21
S2 - Transmit Mode	22
S3 - Step (Digital AFC)	24
S4 - Modem Function	26
Switch Labeling	28
INITIAL TESTING (NO TNC REQUIRED)	29
PLL Initial Alignment	30
PSK Mode Clock Generator Alignment	30
Digital AFC Calibration	31
INTERFACE BOARD CONSTRUCTION	33
TNC Header Installation	36
TNC 2	36
TNC 1	37
BOTH TNC 1 AND TNC 2	38

RADIO PORT WIRING.	38
TNC 1	38
TNC 2	38
BOTH TNC 1 AND TNC 2	39
INITIAL TESTING WITH TNC	39
Initial PSK Loopback Test	40
RADIO INTERFACING.	42
VHF Radio Port	42
UHF Radio Port	42
SPECIFIC RADIO INTERCONNECTS	44
Kenwood TS711A/811A	44
Yaesu FT726R	44
ICOM Radios	45
FINAL CHECK-OUT.	46
CABINET INSTALLATION	49
OPERATION.	50
FSK (Normal)	50
PSK (Terrestrial)	50
Satellite	51
Frequencies	51
Callsign	52
Commands	52
Bulletin	52
Files	53
Help	53
Kill	54
Mine	54
Read	54
Users	54
Write	55
Operation Example	55
Ending the QSO	57
Protocol Version	57
TNC Parameter Settings	57
THEORY OF OPERATION.	58
Power Supply	58
Modulator	58
Demodulator	59
Indicators	60
Digital AFC	61

TROUBLESHOOTING.	62
General	62
Power Supply	62
Modulator	63
Demodulator	64
Indicators	65
Digital AFC	66
Voltages and Waveforms	67
Power Supply	68
Modulator	68
Demodulator	68
Indicators	68
Digital AFC	69
PAD FUNCTIONS.	70
Interface Board	70
Display Board	70
Main Board	71

List of Figures

Fig. 1 - Modem Display Parts Placement Guide	6
Fig. 2 - Resistor Installation	10
Fig. 3 - 6-Conductor Cable Preparation	18
Fig. 4 - Switch Orientation	20
Fig. 5 - S1 Wiring	21
Fig. 6 - S2 Wiring	23
Fig. 7 - S3 Wiring	25
Fig. 8 - S4 Wiring	27
Fig. 9 - Interface Cable Preparation	33
Fig. 10 - Interface Cable Preparation	34
Fig. 11 - 8-Pin DIN Connector Pinout	35
Fig. 12 - Digital AFC for GROUND-activated UP/DOWN	43
Fig. 13 - Digital AFC for +5V-activated UP/DOWN	43
Fig. 14 - ICOM Interface	45
Fig. 15 - Eye Pattern	47

INTRODUCTION

The TAPR PSK Modem kit is intended for the advanced packet experimenter. It offers the potential for a 3 to 8 dB improvement in weak signal work over typical FSK modems. The modem is designed to be compatible with the MicroSat (AO16, LO17 and WO19) and FUJI (FO20) satellite packet systems, as well as being a useful terrestrial point-to-point modem.

The TAPR PSK Modem is designed to easily interface to the TAPR TNC 1 and TNC 2 as well as clones. It is easily interfaced to the AEA PK-232 and Heathkit HK-232 when used in conjunction with a TAPR PK232 Modem Disconnect Upgrade. It has been interfaced to the DRSI PC*PA. The modem may be less straightforward or even impractical to interface to other TNCs. If you are unsure about your TNC, check with the manufacturer to verify whether it has a 16- or 32-times transmit clock available.

The kit consists of three (3) printed circuit boards (PCBs); two are designed to be installed as a set in the Radio Shack 270-252 aluminum enclosure (4" x 2-3/8" x 6") (or Mouser 40UB102 or TAPR PSK cabinet) while the third is an interface board that mounts in the associated TNC at the modem disconnect.

This kit includes all parts and components necessary to fully populate all PC boards, mating connectors, front panel switches and front and rear panel labels. It does NOT include the case, optional front panel control and knob, rear panel power connector, fuses, etc.

A voltmeter and a calibrated oscilloscope are required to align the modem and verify its performance. Access to a frequency counter and audio function generator is desirable.

This manual provides sufficient information for the advanced experimenter to build, align and operate the PSK modem.

Please check the shipment for any possible errata sheet(s) and/or additions/corrections to the instructions provided in this manual.

NOTE: Please note any errors, and send this information, along with any suggestions you may have for improving this manual, to TAPR, PO Box 12925, Tucson AZ 85732.

PARTS LIST

The following parts list includes the components for all three circuit boards.

Capacitors, Ceramic Monolithic, Radial Lead, X7R or Z5U

02	0.001 uF	(102)
01	0.0047 uF	(472)
01	0.01 uF	(103) (do NOT confuse with COG part)
01	0.047 uF	(473)
26	0.1 uF	(104)
02	0.33 uF	(334)

Capacitors, Ceramic Monolithic, Radial Lead, COG

09	0.01 uF	(103)
----	---------	-------

Capacitors, Electrolytic, Radial Lead, 16v or greater

06	10 uF
03	220 uF

Diodes

01	1N4001
02	1N4148
01	LED

Resistors, 1/4 w, 5%, Carbon Film

01	100 ohm	(brown-black-brown-gold)
01	470 ohm	(yellow-violet-brown-gold)
05	1k ohm	(brown-black-red-gold)
01	1.5k ohm	(brown-green-red-gold)
02	2.7k ohm	(red-violet-red-gold)
02	3.3k ohm	(orange-orange-red-gold)
01	5.6k ohm	(green-blue-red-gold)
21	10k ohm	(brown-black-orange-gold)
01	15k ohm	(brown-green-orange-gold)
03	22k ohm	(red-red-orange-gold)
01	33k ohm	(orange-orange-orange-gold)
01	39k ohm	(orange-white-orange-gold)
01	47k ohm	(yellow-violet-orange-gold)
03	100k ohm	(brown-black-yellow-gold)
02	1 Megohm	(brown-black-green-gold)
01	10 Megohm	(brown-black-blue-gold)

Resistors, 1/8 w, 1%, Metal Film

NOTE: 1% resistors may be marked with either the color code or the numeric code indicated.

04	2.74k ohm	(red-violet-yellow-brown-brown)	(2741)
16	10.0k ohm	(brown-black-black-red-brown)	(1002)
08	22.1k ohm	(red-red-brown-red-brown)	(2212)

Trim pots

01	5k ohm	(3299W-502)
01	10k ohm	(3299W-103)
02	100k ohm	(3299W-104)

Integrated Circuits

NOTE: The IC number called out may be only a portion of the actual number marked on the part. For example, a "4013" may be marked CD4013BE, or MC14013BP, or some other combination which includes the sequence "4013."

01	74C164	CMOS Shift Register
01	74HC14	CMOS Hex Schmitt Inverter
01	4013	CMOS Dual D Flip Flop
02	4024	CMOS 7-stage Counter
01	4030	CMOS Quad Exclusive-Or Gate
	or	
01	4070	CMOS Quad Exclusive-Or Gate
01	4046	CMOS PLL
02	4066	CMOS Quad Analog Switch
01	ILD-2	Dual Opto Coupler
01	555	Timer
01	556	Dual Timer
01	LM3914	Bar Graph Driver
01	LM3915	Bar Graph Driver
02	LTA1000	Bar Graph Display
04	TL084	Hi Z Quad Op Amp (may be TLC274)
01	TLC274	Hi Z Op Amp

Voltage Regulators

01	LM2930-5.0
01	7805

Connectors

04	02-pin male header
02	06-pin male header (or 01 12-pin male header)
01	20-pin male header
01	20-pin female header
03	05-pin DIN, PC-mount, right-angle
01	08-pin DIN, PC-mount, right angle
03	05-pin DIN, cable type
01	08-pin DIN, cable type
02	02-pin push-on jumper

IC Sockets

02	08-pin IC Socket
14	14-pin IC Socket
01	16-pin IC Socket
02	18-pin IC socket
02	20-pin IC socket

Switches

02	SPDT Toggle, with hardware
01	DPDT Center-Off Toggle, with hardware
01	3PDT Toggle, with hardware

Miscellaneous

01	PC Board, PSK Modem Display, Rev B
01	PC Board, Modem Interface

Packed Separately

01	PC Board, PSK Modem, Rev C
06 Feet	08-conductor, shielded cable
04 Feet	10-conductor "rainbow" ribbon cable
01	Manual
01	Schematic Diagram (3 sheets)
01	Assembly Drawing for PSK Modem PC Board
01	Front Panel Stick-on Label
01	Rear Panel Stick-on Label
01	Front and Rear Panel Dimensions Template
01	Warning Sheet

CONSTRUCTION

The TAPR PSK Modem kit is intended for advanced experimenters. Knowledge of proper soldering techniques, assembly procedures, static precautions, etc. is assumed. Further, access to an accurate frequency counter, an audio frequency oscillator or function generator, and an oscilloscope is required.

The order of assembly and check-out presented on the following pages has been tested by a number of experienced amateurs. We suggest you follow the steps in the order given, checking off each step as it is accomplished.

Tools required to assemble and test the PSK modem include: a low wattage, temperature controlled soldering iron with a very small tip (don't forget to keep the tip clean!); long-nose pliers; diagonal cutting pliers; a small screwdriver for adjusting the trimpot screws; a ruler for measuring wire lengths. Additional tools that may prove helpful include: a jeweler's loupe or magnifying glass for checking tight places on the PC board; IC insertion tools; a lead bending jig.

In addition, limited metalworking tools, such as a drill and a nibbler, will be necessary for the cabinet work.

As always, if you have any comments or constructive criticism regarding this manual or the kit itself, please send them to Tucson Amateur Packet Radio, PO Box 12925, Tucson AZ 85732.

Good luck -- and see you on the satellites!

DISPLAY BOARD

(This PC board is silkscreened TAPR/JAS PSK MODEM DISPLAY Rev B.)

Check the PC board and verify that the exposed, tinned pads are clean and shiny. If they are not, scrub the board lightly with a household cleanser (such as "Ajax" or "Comet") and rinse with clean water, then dry with a soft towel.

() PC board clean.

Refer to the layout diagram on the bottom of this page for clarification of any parts placement ambiguities.

Install the following 5% resistors:

() R100 1.5k ohm (brown-green-red-gold)
 () R102 100k ohm (brown-black-yellow-gold)
 () R101 470 ohm (yellow-violet-brown-gold)
 () R103 2.7k ohm (red-violet-red-gold)
 () R104 3.3k ohm (orange-orange-red-gold)
 () R105 3.3k ohm (orange-orange-red-gold)

() Solder and trim the leads (12 total). Be sure that no solder bridge is formed at the adjacent ends of R103 and R104.

Install the following capacitors (see the diagram below for placement of these capacitors):

() C101 0.1 uF (104)
 () C102 0.1 uF (104)

() Solder and trim the leads (4 total).

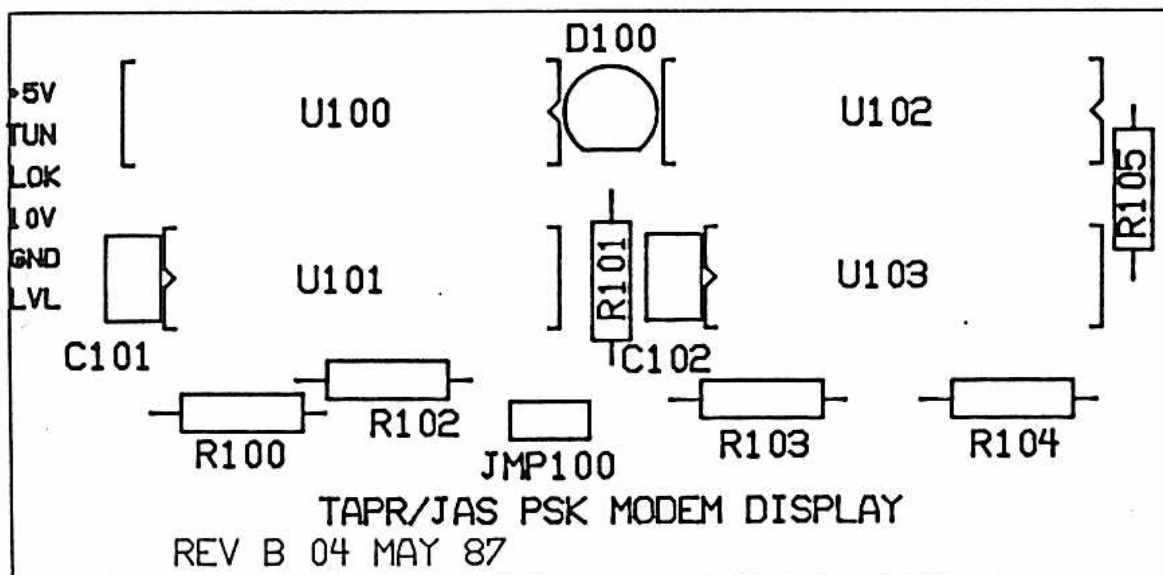

Fig. 1 - Modem Display Parts Placement Guide

Install the following IC sockets:

NOTE: IC sockets are polarized, with the end nearest pin 1 marked with a notch, a beveled corner or the numeral 1 embossed in the body of the socket. The PC board silkscreen is marked with a notch at the pin 1 end.

When installing an IC socket, be sure ALL pins are through the PC board, then tack solder a diagonally opposite pair of corners. Double check that the socket is properly seated and that all pins are through, then solder the remaining pins. Finally, resolder the original two tack-soldered pins.

() U101 18-pin IC socket
 () U103 18-pin IC socket

NOTE: The 20-pin sockets are oriented opposite to the 18-pin sockets just installed.

() U100 20-pin IC socket
 () U102 20-pin IC socket

In the next two steps, you will be installing the bargraph display ICs at U100 and U102. The bargraph displays are marked with a beveled corner at pin 1. Be sure the displays are firmly seated in their respective sockets.

() U100 LTA1000
 () U102 LTA1000

Install the following LED:

NOTE: The LED will be installed between the two bargraph displays. The rounded "lens" of the LED should protrude somewhat farther from the board than the displays; the exact distance is not critical and depends on your personal preference. Because the LED is a polarity sensitive device, be sure that the flat on the side of the LED is lined up with the flat on the PC board silkscreen.

() D100 LED
 () Solder and trim the leads (2 total).

NOTE: The header in the next step may interfere with mounting the Display PCB in the cabinet. The installation of the header is optional.

Install and solder the following header:

() JP100 02-pin male

Install the following ICs, paying careful attention to the polarity of the ICs and their respective sockets.

- () U101 LM3915
- () U103 LM3914

Carefully inspect the board for any solder bridges, untrimmed or unsoldered leads, or other faults.

- () OK so far!

() Set aside the DISPLAY PC board and prepare to assemble the main PSK modem PC board.

MAIN BOARD

Check the PC board and verify that the exposed, tinned pads are clean and shiny. If they are not, scrub the board lightly with a household cleanser (such as "Ajax" or "Comet") and rinse with clean water, then dry with a soft towel.

() PC board clean.

Component installation will generally proceed from left to right and top to bottom of the PC board when held so that the silkscreen legend "PSK MODEM REV C" is in the normal reading position.

Install the following IC sockets:

NOTE: IC sockets are polarized, with the end nearest pin 1 marked with a notch, a beveled corner, or the numeral 1 embossed in the plastic body of the socket. The PC board silkscreen is marked with a notch at the pin 1 end.

When installing an IC socket, be sure ALL pins are through the PC board, then tack solder a diagonally opposite pair of corners. Double check that the socket is properly seated and that all pins are through, then solder the remaining pins. Finally, resolder the original two tack-soldered pins.

()	U24	08-pin
()	U21	14-pin
()	U17	14-pin
()	U18	14-pin
()	U16	14-pin
()	U3	14-pin
()	U2	14-pin
()	U1	14-pin
()	U8	14-pin
()	U7	14-pin
()	U9	14-pin
()	U10	14-pin
()	U11	14-pin
()	U6	16-pin
()	U5	14-pin
()	U4	14-pin
()	U12	08-pin

There should be no IC sockets remaining.

() No IC sockets remaining.

Install the following 5% resistors:

NOTE: The resistors mount on one end as illustrated below. The "body" end is marked with a ring on the silkscreen. The schematic has a dot near the end that is standing up, away from the PC board. The orientation of the resistors has been chosen for usefulness as test points should troubleshooting be required later. Please pay careful attention to the resistor orientations.

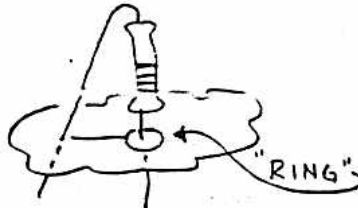

Fig. 2 - Resistor Installation

- () R79 10k ohm (brown-black-orange-gold)
- () R7 22k ohm (red-red-orange-gold)
- () R81 1k ohm (brown-black-red-gold)
- () R5 22k ohm (red-red-orange-gold)
- () R76 10k ohm (brown-black-orange-gold)

- () Solder and trim the leads (10 total).

- () R4 10k ohm (brown-black-orange-gold)
- () R2 10k ohm (brown-black-orange-gold)
- () R17 100k ohm (brown-black-yellow-gold)
- () R3 1k ohm (brown-black-red-gold)
- () R1 1k ohm (brown-black-red-gold)

- () Solder and trim the leads (10 total).

- () R12 10k ohm (brown-black-orange-gold)
- () R21 10k ohm (brown-black-orange-gold)
- () R43 10k ohm (brown-black-orange-gold)
- () R36 10k ohm (brown-black-orange-gold)
- () R78 10k ohm (brown-black-orange-gold)
- () R9 100k ohm (brown-black-yellow-gold)
- () R18 10k ohm (brown-black-orange-gold)

- () Solder and trim the leads (14 total).

- () R51 1 Megohm (brown-black-green-gold)
- () R50 10k ohm (brown-black-orange-gold)
- () R29 33k ohm (orange-orange-orange-gold)
- () R28 10k ohm (brown-black-orange-gold)
- () R82 10 Megohm (brown-black-blue-gold)
- () R77 10k ohm (brown-black-orange-gold)
- () R30 39k ohm (orange-white-orange-gold)

- () Solder and trim the leads (14 total).

() R54 15k ohm (brown-green-orange-gold)
 () R56 10k ohm (brown-black-orange-gold)
 () R64 10k ohm (brown-black-orange-gold)
 () R65 10k ohm (brown-black-orange-gold)
 () R62 10k ohm (brown-black-orange-gold)
 () R63 10k ohm (brown-black-orange-gold)
 () R8 1k ohm (brown-black-red-gold)

() Solder and trim the leads (14 total).

() R53 100 ohm (brown-black-brown-gold)
 () R74 10k ohm (brown-black-orange-gold)
 () R52 5.6k ohm (green-blue-red-gold)
 () R31 47k ohm (yellow-violet-orange-gold)
 () R68 1 Megohm (brown-black-green-gold)
 () R32 22k ohm (red-red-orange-gold)

() Solder and trim the leads (12 total).

() R55 1k ohm (brown-black-red-gold)
 () R59 10k ohm (brown-black-orange-gold)
 () R60 10k ohm (brown-black-orange-gold)
 () R75 2.7k ohm (red-violet-red-gold)

() Solder and trim the leads (8 total).

There should be no 5% resistors remaining.

() No 5% resistors remaining.

Install the following 1% resistors:

NOTE: 1% resistors may be color-coded or marked with the printed value indicated in the following steps.

() R13 22.1k ohm (red-red-brown-red-brown) (2212)
 () R16 10.0k ohm (brown-black-black-red-brown) (1002)
 () R14 22.1k ohm (red-red-brown-red-brown) (2212)
 () R15 2.74k ohm (red-violet-yellow-brown-brown) (2741)

() Solder and trim the leads (8 total).

() R24 2.74k ohm (red-violet-yellow-brown-brown) (2741)
 () R25 10.0k ohm (brown-black-black-red-brown) (1002)
 () R23 22.1k ohm (red-red-brown-red-brown) (2212)
 () R22 22.1k ohm (red-red-brown-red-brown) (2212)

() Solder and trim the leads (8 total).

() R11 10.0k ohm (brown-black-black-red-brown) (1002)
 () R20 10.0k ohm (brown-black-black-red-brown) (1002)
 () R19 10.0k ohm (brown-black-black-red-brown) (1002)
 () R10 10.0k ohm (brown-black-black-red-brown) (1002)

() Solder and trim the leads (8 total).
 () R38 22.1k ohm (red-red-brown-red-brown) (2212)
 () R39 2.74k ohm (red-violet-yellow-brown-brown) (2741)
 () R40 10.0k ohm (brown-black-black-red-brown) (1002)
 () R48 10.0k ohm (brown-black-black-red-brown) (1002)
 () R49 10.0k ohm (brown-black-black-red-brown) (1002)

() Solder and trim the leads (10 total).
 () R46 2.74k ohm (red-violet-yellow-brown-brown) (2741)
 () R45 22.1k ohm (red-red-brown-red-brown) (2212)
 () R47 10.0k ohm (brown-black-black-red-brown) (1002)
 () R27 10.0k ohm (brown-black-black-red-brown) (1002)
 () R26 10.0k ohm (brown-black-black-red-brown) (1002)

() Solder and trim the leads (10 total).
 () R44 22.1k ohm (red-red-brown-red-brown) (2212)
 () R37 22.1k ohm (red-red-brown-red-brown) (2212)
 () R41 10.0k ohm (brown-black-black-red-brown) (1002)
 () R34 10.0k ohm (brown-black-black-red-brown) (1002)
 () R42 10.0k ohm (brown-black-black-red-brown) (1002)
 () R35 10.0k ohm (brown-black-black-red-brown) (1002)

() Solder and trim the leads (12 total).

There should be no 1% resistors remaining.

() No 1% resistors remaining.

Now, carefully check to see that no resistor leads are touching adjacent or nearby component leads, and that the wire loops at the tops of the resistors are not shorting to any adjacent leads.

() No leads touching.

Install the following COG ceramic monolithic capacitors:

() C38 0.01 uF (103)
 () C18 0.01 uF (103)
 () C17 0.01 uF (103)
 () C20 0.01 uF (103)
 () C21 0.01 uF (103)

() Solder and trim the leads (10 total).

() C25 0.01 uF (103)
 () C24 0.01 uF (103)
 () C26 0.01 uF (103)
 () C27 0.01 uF (103)

() Solder and trim the leads (8 total).

There should be no COG capacitors remaining.

() No COG capacitors remaining.
Install the following ceramic monolithic capacitors:

In the next two steps, the PC pads may be too widely spaced for the capacitors supplied. If so, bend the leads away from the body of the capacitor, then bend them again so that they will easily fit in the PC board without stressing the capacitor case.

() C22 0.1 uF (104)
() C23 0.0047 uF (472)

() Solder and trim the leads (4 total).

() C8 0.047 uF (473)
() C37 0.1 uF (104)
() C7 0.1 uF (104)
() C50 0.1 uF (104)
() C46 0.1 uF (104)

() Solder and trim the leads (10 total).

() C47 0.1 uF (104)
() C51 0.001 uF (102)
() C49 0.001 uF (102)
() C45 0.1 uF (104)

() Solder and trim the leads (8 total).

() C12 0.1 uF (104)
() C10 0.1 uF (104)
() C39 0.1 uF (104)
() C40 0.1 uF (104)
() C36 0.1 uF (104)
() C41 0.1 uF (104)

() Solder and trim the leads (12 total).

() C6 0.1 uF (104)
() C28 0.1 uF (104)
() C42 0.1 uF (104)
() C30 0.33 uF (334)

() Solder and trim the leads (8 total).

() C43 0.1 uF (104)
() C33 0.1 uF (104)
() C44 0.1 uF (104)
() C31 0.1 uF (104)

() Solder and trim the leads (8 total).

() C2 0.1 uF (104)
 () C4 0.1 uF (104)
 () C11 0.1 uF (104)
 () C35 0.01 uF (103)
 () C29 0.33 uF (334)

() Solder and trim the leads (10 total).

There should be one capacitor (0.1 uF) remaining.

() One capacitor remaining.

Install the following electrolytic capacitors:

NOTE: Electrolytic capacitors are polarized components. The **positive** lead is usually silkscreened on the PC board, and **always** goes to the square pad in the capacitor outline. The **negative** lead is usually marked with a stripe or band on the capacitor body. Pay close attention to capacitor polarity in the following steps.

() C9 10 uF
 () C5 220 uF
 () C1 220 uF
 () C3 220 uF

() Solder and trim the leads (8 total).

NOTE: If your 70-cm radio tunes in 10 Hz steps and you plan on operating through the MicroSats, you may wish to change C32 and C34 from 10 uF to either 2.2 or 4.7 uF capacitors for better tracking on high passes.

() C19 10 uF
 () C16 10 uF
 () C34 10 uF
 () C32 10 uF
 () C48 10 uF

() Solder and trim the leads (10 total).

There should be no electrolytic capacitors remaining.

() No electrolytic capacitors remaining.

Install the following diodes:

NOTE: Diodes are polarity sensitive devices. The banded end of the diode (cathode) should be oriented toward the cathode symbol on the silkscreen. The cathode lead always goes through the square pad on the PC board. Diodes are mounted standing on one end, like the resistors previously installed. The anode end of the diode body should be against the PC board.

() D1 1N4001

() D2 1N4148
 () D3 1N4148

() Solder and trim the leads (6 total).

There should be no diodes remaining.

() No diodes remaining.

Install the following trimpots.

NOTE: When installing trimpots, place the part on the PC board and tack solder the center lead. After you are satisfied with the mechanical alignment of the part, solder the remaining leads and trim them.

() R80 100k ohm (104)
 () R6 5k ohm (502)
 () R33 100k ohm (104)
 () R61 10k ohm (103)

There should be no trimpots remaining.

() No trimpots remaining.

Install and solder the following PC-mount, right-angle DIN connectors:

() J1 8-pin DIN
 () J2 5-pin DIN
 () J3 5-pin DIN
 () J4 5-pin DIN

Install and solder the following voltage regulators:

NOTE: The voltage regulators are polarized. The metal tab should be aligned with the double-stripped portion of the silkscreen outline.

NOTE: The two voltage regulators are oriented opposite to each other. Pay careful attention to the silkscreen outline!

() VR1 LM7805CT regulator (tab towards board edge)
 () VR2 LM2930-5.0 low-drop regulator (tab opposite)

Install and solder the following headers:

() JP8 02-pin male header
 () JP7 02-pin male header
 () JP4 02-pin male header

NOTE: The following two 6-pin headers may be supplied as a single 12-pin header.

() JP5 06-pin male header
 () JP6 06-pin male header

At this point, some preliminary checking of the main PCB is in order. First, check the board visually and make sure no solder splashes, bridges, cold solder joints or other obvious problems exist.

() Visual inspection OK.

() Apply a source of 12 volts dc nominal (may be from 10.5 to 16 volts), with + to pad 6 and - to pad 20.

Measured value is _____.

() Check for +5v at the +5V pad adjacent to pad 6. The value should be between +4.7 and +5.3 vdc.

Measured value is _____.

() Check for +10v at the +10V pad between U6 and C11. The voltage should be between +9.4 and +10.6 vdc.

Measured value is _____.

() Remove power.

If any of the above values are not in tolerance, correct the problem before proceeding. See the Troubleshooting section for assistance.

() Voltages OK.

Install the following integrated circuit. Carefully observe polarity of the IC.

() U8 TL084 Hi Z Quad Op Amp

NOTE: In the following step, it may take several seconds for the voltage to stabilize.

() Reapply power, and measure the voltage at U8 pin 14. It should be within 100 mV of the same value as measured on the +5V pad, above.

Measured value is _____.

() Remove power.

If the preceding checks are all satisfactory, install the following ICs. If not, determine the cause of the problem, and remedy it, before proceeding.

() Voltage OK.

When installing the ICs, take precautions against static discharge! Work on a conductive surface, if possible. Touch the ground trace on the PC board after you have the IC in your hand, but before placing the IC in its socket. If you are in a carpeted area, spray the carpet with a 50% solution of "Downey" or other fabric softener to preclude static build-up.

()	U24	555	Timer
()	U21	4030	CMOS Quad Exclusive-Or Gate (or 4070)
()	U17	4013	CMOS Dual D Flip Flop
()	U18	4024	CMOS 7-stage Counter
()	U16	74HC14	CMOS Hex Schmitt Inverter
()	U3	TL084	Hi Z Quad Op Amp
()	U2	TL084	Hi Z Quad Op Amp
()	U1	4066	CMOS Quad Analog Switch
()	U7	TL084	Hi Z Quad Op Amp
()	U9	4066	CMOS Quad Analog Switch
()	U10	TLC274	Hi Z Quad Op Amp
()	U11	556	Dual Timer
()	U6	4046	CMOS PLL
()	U5	4024	CMOS 7-stage Counter
()	U4	74C164	CMOS Shift Register
()	U12	ILD2	Dual Opto Coupler

() Verify that all ICs are in their proper location and properly seated in their respective sockets.

() Carefully inspect the PC board for any shorts or poor solder joints.

() Set the Main PC board aside until called for later in the instructions.

The following steps are concerned with completing the Display PC board and wiring it to the Main PC board.

6-CONDUCTOR CABLE PREPARATION

NOTE: You may wire the cabling to the Main PC board from the top or the bottom of the board. Bottom wiring may look neater. If you desire to route the cabling below the board, add 1-1/2" (3.8 cm) to the overall length of the cable.

See the illustration below for clarification during the following steps.

() Separate a 5-1/2" (14 cm) long piece of 10-conductor ribbon cable between the blue and violet wire.

() Cut off the 6-conductor portion (brown-red-orange-yellow-green-blue).

() Separate the individual wires for a distance of 1/2" (1.3 cm) at one end only of the 6-conductor cable.

() Strip 1/8" (3 mm) of insulation from each end of the six conductors at this end.

() Twist each wire's strands together and tin the six resulting wire ends.

() Separate the individual wires of the other end of the cable for a distance of 3-1/2" (8.9 cm). (All six conductors should be together for a length of about 1-1/2 inches (3.8 cm).)

() Now trim the cable wires to the following lengths:

BROWN	4-1/4"	(10.8 cm)	(SAVE THIS CUTTING!)
RED	4-3/4"	(12.1 cm)	
ORANGE	5-1/2"	(14 cm)	
YELLOW	4-3/4"	(12.1 cm)	
GREEN	4-1/4"	(10.8 cm)	(SAVE THIS CUTTING!)
BLUE	4-3/4"	(12.1 cm)	

() Strip 1/8" (3 mm) of insulation from each of the six conductors at the newly trimmed end.

() Twist each wire's strands together and tin the six resulting wire ends.

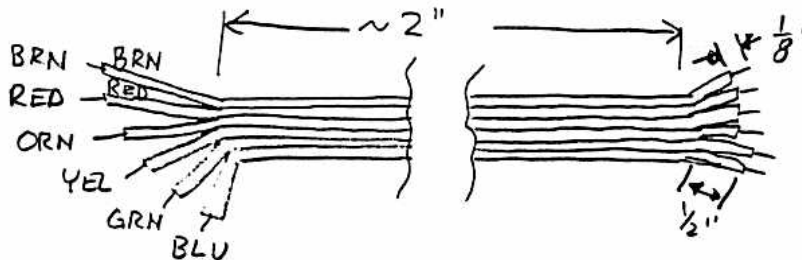

Fig. 3 - 6-Conductor Cable Preparation

DISPLAY BOARD TERMINATION

Attach the end of the 6-conductor cable whose ends are the same length to the DISPLAY BOARD as follows:

() Insert the ORANGE wire into the hole on the display board marked "LOK" and solder.

() Insert the YELLOW wire into the hole on the display board marked "10V" and solder.

() Insert the RED wire into the hole on the display board marked "TUN" and solder.

() Insert the GREEN wire into the hole on the display board marked "GND" and solder.

() Insert the BROWN wire into the hole on the display board marked "+5V" and solder.

() Insert the BLUE wire into the hole on the display board marked "LVL" and solder.

() Trim the excess leads from the PC board at the six locations just soldered.

() On the solder side of the DISPLAY BOARD, solder the remaining 0.1 uF capacitor at the "+5V" (brown wire) and "GND" (green wire) solder pads.

() Check the display board carefully for any shorts or unsoldered joints.

MAIN BOARD TERMINATION

Attach the other end of the cable to the main board as follows:

() Insert the BROWN wire into the hole at the pad marked "+5V" (between VR1 and VR2) and solder.

() Insert the RED wire into the hole at the pad marked "14" (near U6 pin 11) and solder.

() Insert the ORANGE wire into the hole at the pad marked "12" (near U16 pin 10) and solder.

() Insert the YELLOW wire into the hole at the pad marked "+10V" (near U6 pin 14) and solder.

() Insert the GREEN wire into the hole at the pad marked "GND" (near tab side of VR1) and solder.

() Insert the BLUE wire into the hole at the pad marked "19" (near U4 pin 1) and solder.

FRONT PANEL WIRING

This section deals with the wiring of the switches on the front panel of your modem.

NOTE: The wire lengths given refer specifically to the Radio Shack cabinet. If you elect to use a different cabinet, you may need to alter the lengths.

NOTE: The wire lengths given further assume that you will mount the switch below the main PC board. If you choose to route the switch wiring above the board, the lengths given will probably have to be altered.

Some builders may want to include more switches than the included set for greater flexibility in experimentation (such as a TNC 1/TNC 2 selector switch), or hard-wire the modem for a specific configuration (no MANCHESTER transmit mode) and use fewer switches. For these special purposes, consult the notes on the schematics and at the end of this manual for PC board pad definitions.

The switch wiring will use much of the remaining 10-conductor rainbow ribbon cable. Don't worry if you use it all - there is no further requirement for the cable apart from switch wiring.

All switches will be referred to by TOP and BOTTOM. The illustration below shows the orientation of the switch keyway, used to determine TOP and BOTTOM.

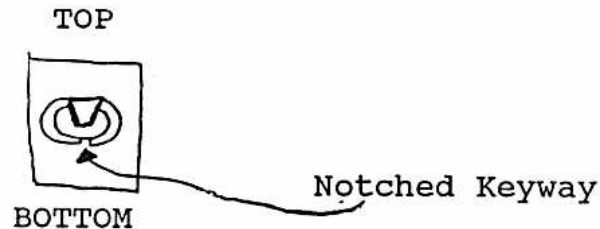

Fig. 4 - Switch Orientation

NOTE: When wiring the switch lugs, you may wish to use 1/4" (6 mm) lengths of heat shrink tubing to strain relieve and dress up the appearance of the switch wiring.

S1 - Receive Mode

Switch S1 is used to select the source of the received audio signal. In the JOINT position, audio from the VHF radio port will be used. In the SPLIT position, audio from the UHF radio port will be used. JOINT is applicable to users of combined radios, such as the Yaesu FT726 or FT736, the Kenwood TS-790 or the ICOM IC-970 while the SPLIT position is applicable to users of separate radios, such as the Kenwood TS711/811 or ICOM IC271/ 471 pairs.

() Separate an 8-1/2" (21.6 cm) length of ribbon cable, three conductors wide (colors yellow-green-blue).

() Separate the individual wires for a distance of 1/2" (1.3 cm) at both ends of the cable.

() Strip 1/8" (3mm) of insulation from each end of each conductor (six total).

() Twist together each wire's strands and tin the ends (six total).

() Select a SPDT switch (3 terminals on rear) for use as S1.

() At one end of the 3-wire cable, solder the YELLOW wire to the TOP lug on the rear of S1.

() Solder the GREEN wire to the CENTER lug on the rear of S1.

() Solder the BLUE wire to the BOTTOM lug on the rear of S1.

() At the other end of the 3-wire cable, solder the BLUE wire to JP3 pad 1 (square pad, near R8).

() Solder the GREEN wire to JP3 pad 2 (center pad).

() Solder the YELLOW wire to JP3 pad 3 (near C32).

S1 Rear View

Fig. 5 - S1 Wiring

S2 - Transmit Mode

Switch S2 is used to select the PSK modulator clock.

In the PSK position, a free-running clock source is utilized by the PSK modulator. This mode would typically be used for weak signal, HF, or other non-satellite operation.

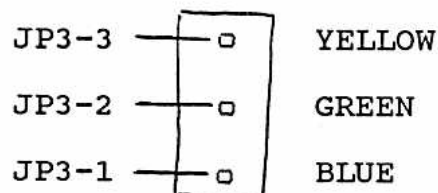
In the other position, marked MAN (for Manchester) on the front panel sticker, a synchronized clock source is generated to provide a PSK signal suitable for use by the MicroSat and FUJI Mode JD transponders.

() Separate a 7" (17.8 cm) length of ribbon cable, three conductors wide (colors brown-red-orange).

() Separate the individual wires for a distance of 1/2" (1.3 cm) at one end of the cable.

() Separate the individual wires for a distance of 1-1/2" (3.8 cm) at the other end.

() Strip 1/8" (3mm) of insulation from each end of each conductor (six total).

() Twist together each wire's strands and tin the ends (six total).

() Select a SPDT switch (3 terminals on rear) for use as S2.

() At the end of the 3-wire cable which is separated for a distance of 1/2 " (1.3 cm), solder the BROWN wire to the TOP lug on the rear of S2.

() Solder the RED wire to the CENTER lug on the rear of S2.

() Solder the ORANGE wire to the BOTTOM lug on the rear of S2.

() At the other end of the 3-wire cable, solder the BROWN wire to Pad 1 (near U17 pin 1).

() Solder the RED wire to Pad 4 (near U21 pin 7).

Now it is decision time! You must decide whether to wire the PSK modem for use with a TAPR TNC 1 (or TAPR Beta TNC, AEA PKT-1, AEA PK-232, Heath HD-4040 or Heath HK-232), or a TAPR TNC 2 (or clone). If you aren't going to operate in the MANCHESTER (FUJI) transmit mode, it doesn't matter. Otherwise, if you are interfacing the PSK modem to a different TNC, you must find out if the TNC uses a 32x clock or a 16x clock in its NRZI-NRZ DPLL clock recovery circuit. If it uses a 32x clock (38.4 kHz for 1200 baud operation - TNCs using 8530 SCC chips generate a 32x clock), use the TNC 1 directions. If it uses a 16x clock (19.2 kHz for 1200 baud operation), use the TNC 2 directions.

() If you are using a TNC 1, solder the ORANGE wire to Pad 2 (near U18 pin 6).

() If you are using a TNC 2, solder the ORANGE wire to Pad 3 (near U18 pin 7).

S2 Rear View

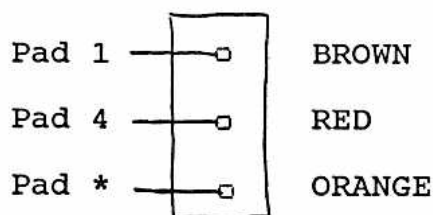

* Pad 2 for TNC 1, Pad 3 for TNC 2

Fig. 6 - S2 Wiring

S3 - Step (Digital AFC)

Switch S3 is used to enable or disable the digital AFC circuitry. When enabled, it selects the polarity of the AFC signal.

Digital AFC is used primarily to track the Doppler shift that results from the rapid motion of a satellite. If you don't intend to operate on a low-earth orbit satellite, this switch function probably won't be of much use to you. On the other hand, if you plan on at least listening to packet signals from FUJI or the MicroSats, and your radio has UP/DOWN remote input (usually found on the accessory or microphone connectors), digital AFC will be indispensable.

() Separate an 8" (19.4 cm) length of ribbon cable, four conductors wide (colors violet-gray-black-white).

() Separate the individual wires for a distance of 1/2" (1.3 cm) at one end of the cable.

() Separate the individual wires for a distance of 1" (2.5 cm) at the other end of the cable.

() Strip 1/8" (3mm) of insulation from each end of each conductor (eight total).

() Twist together each wire's strands and tin the ends (eight total).

() Locate the BROWN and GREEN cuttings from the 6-wire DISPLAY board cable.

() Strip 1/8" (3mm) of insulation from each end of each wire (four total).

() Twist together each wire end's strands and tin the ends (four total).

() Select the DPDT, center-off switch (6 terminals on rear) for use as S3.

() At the end of the 4-wire cable which is separated for a distance of 1/2" (1.3 cm), solder the GRAY wire to the LEFT CENTER lug on the rear of S3.

() Solder the WHITE wire to the RIGHT CENTER lug on the rear of S3.

() Solder one end of the BROWN cutting-wire to the TOP RIGHT lug on the rear of S3.

() Solder the other end of this wire, along with the BLACK wire of the 4-wire cable, to the BOTTOM LEFT lug on the rear of switch S3.

() Solder one end of the GREEN cutting-wire to the BOTTOM RIGHT lug on the rear of S3.

() Solder the free end of this wire, along with the remaining VIOLET wire, to the TOP LEFT lug on the rear of S3.

() At the other end of the 4-wire cable, solder the BLACK wire to Pad 24 (near U12 pin 5).

() Solder the WHITE wire to Pad 21 (near U11 pin 7).

() Solder the GRAY wire to Pad 23 (near U11 pin 8).

() Solder the VIOLET wire to Pad 22 (near U12 pin 1).

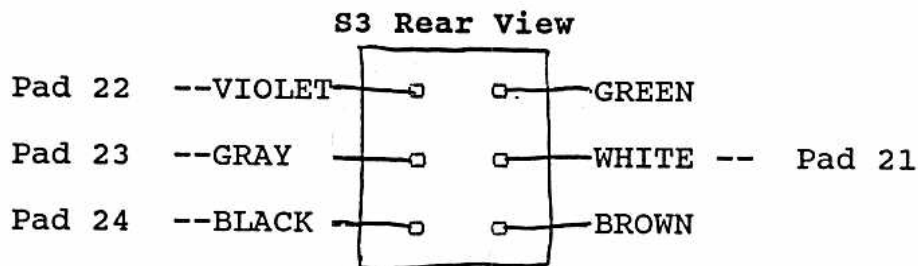

Fig. 7 - S3 Wiring

S4 - Modem Function

Switch S4 is used to enable or disable the PSK modem.

In the OFF position, the TNC's internal modem (FSK) is selected.

In the ON position, the PSK modem is selected and the TNC's internal modem disconnected from the TNC's digital processing circuitry.

() Separate an 8-1/2" (21.6 cm) length of ribbon cable, nine conductors wide (colors brown-red-orange-yellow-green-blue- violet-gray-white).

() Separate the individual wires for a distance of 1" (2.5 cm) at both ends of the cable.

() At one end of the cable, separate the VIOLET-GRAY pair for an additional 1" (2.5 cm), or a total of 2" (5 cm) from the rest of the cable. The individual wires should still be separated for a distance of 1" (2.5 cm).

() At the same end of the cable used in the previous step, separate the WHITE wire for a distance of 4-1/2 " (11.4 cm). Cut off 2-3/4" (7 cm) of this WHITE wire.

() Strip 1/8" (3mm) of insulation from each end of each conductor (eighteen total).

() Twist together each wire's strands and tin the ends (eighteen total).

() Working with the end of the cable whose ends are the same length, solder the BROWN wire to the TOP LEFT lug on the rear of switch S4.

() Solder the RED wire to the CENTER LEFT lug on the rear of S4.

() Solder the ORANGE wire to the BOTTOM LEFT lug on the rear of S4.

() Solder the YELLOW wire to the TOP CENTER lug on the rear of S4.

() Solder the GREEN wire to the CENTER CENTER lug on the rear of S4.

() Solder the BLUE wire to the BOTTOM CENTER lug on the rear of S4.

() Solder the VIOLET wire to the TOP RIGHT lug on the rear of S4.

- () Solder the GRAY wire to the CENTER RIGHT lug on the rear of S4.
- () Solder the WHITE wire to the BOTTOM RIGHT lug on the rear of S4.
- () At the other end of the cable, solder the GRAY wire to Pad 8 (between C16 and J3).
- () Solder the VIOLET wire to Pad 7 (between C19 and J1).
- () Solder the BLUE wire to Pad 13 (near U16 pin 12).
- () Solder the GREEN wire to Pad 15 (between Pad 13 and J1).
- () Solder the YELLOW wire to Pad 16 (next to Pad 15).
- () Solder the ORANGE wire to Pad 11 (near U16 pin 8).
- () Solder the RED wire to Pad 17 (next to Pad 16).
- () Solder the BROWN wire to Pad 18 (between U16 pin 9 and J1).
- () Solder the WHITE wire to Pad 5 (at the left end of the board between C8 and C9).

S4 Rear View

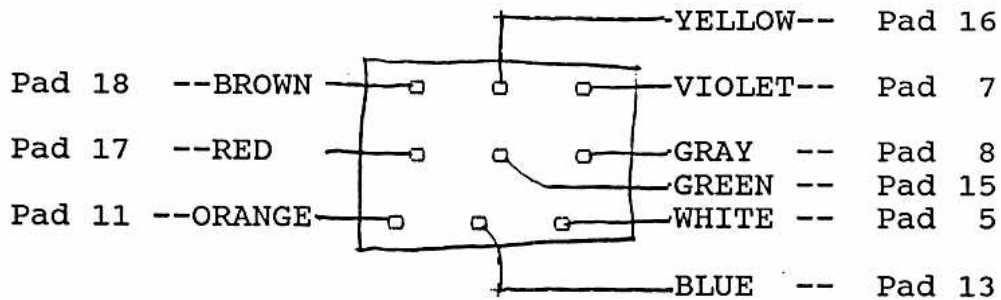

Fig. 8 - S4 Wiring

SWITCH LABELING

When wired according to the previous instructions, the following labeling applies:

	S1 RX	S2 TX	S3 STEP	S4 MODEM
UP	JOINT	MAN	USB	ON
CENTER	N/A	N/A	OFF	N/A
DOWN	SPLIT	PSK	LSB	OFF

In addition, a front or rear panel audio input level control may be desirable if your receiver provides a non-adjustable audio output level. Use a 50k potentiometer and connect it as shown on the schematic, sheet 3. If no such control is desired, simply short pads 9 and 10 on the Main PC board.

NOTE: A 10K fixed resistor may be installed across pads 9 and 10. During testing in the MicroSat lab, this value was found to work well with the Kenwood and ICOM radios used to check out the satellites before launch.

() Audio level control wired.

OR

() Pads 9 and 10 jumpered.

Now, recheck all wiring. Look especially for insulation pierced by sharp leads or IC socket pins. Verify that all connections are soldered. If you used heat-shrink tubing, be sure it is in place and properly shrunk on the switch lugs.

() OK so far.

INITIAL TESTING (NO TNC REQUIRED)

The following tests will check the operation of most of the circuitry of the PSK Modem, calibrating it at the same time.

() Connect a power source (switched OFF) to the Main board, with + to pad 6 and - to pad 20.

() Apply an input voltage of +11 to +16 vdc.

() Verify that the current drain is under 150 mA (with no displays on, the current drain is under 30 mA, typically).

() The bar graph LED displays normally flash when power is applied.

() After a few seconds, the displays should settle down, and one LED in each bar graph may be illuminated.

() Short Main board pads 9 and 10 (or reduce the optional level control to 0 ohms).

() Inject a sine wave of about 50 mV pk-pk at 1600 Hz to JP3 center pad (or S1 center pin) and ground. The 8th LED of bar graph U100 (LEVEL) should be lit. If it is not, adjust the input level until it is. If you added an input level control, be sure to set it for maximum gain.

NOTE: If a sine-wave generator is not available, set R80 for a 1600 Hz square wave (period on oscilloscope of 625 uSec) at U17 pin 1. Obtain the tone from the ungrounded end of JP8, setting R6 for the desired amplitude level, and placing front panel switch S2 in the "PSK" position to short Main board pad 1 to pad 4.

() Connect an oscilloscope to the top of R9 (near U8 pin 8) and note that the waveform is not clipped and is about 4v to 6v pk-pk when segment 10 just lights.

() With the scope still connected to the top of R9 (near U8 pin 8), increase the audio drive and note that the last LED in the LEVEL display is on at about the level at which some clipping of the observed waveform occurs (about 6 v pk-pk).

() Shorting jumper JP100 on the display board should cause the LEVEL display to change from a moving dot (default) to a bar display. Use the setting which you prefer.

NOTE: If you use the bar display, you may want to clip a heat sink on the tab of 5-volt regulator VR1, as it will run considerably warmer. The moving dot mode may provide more information about the received signal's characteristics.

() Remove the input signal.

The following steps deal with aligning the PLL.

() Install a push-on jumper at JP4.

NOTE: If the following step is unsuccessful, suspect the PLL IC, U6 (4046).

() Connect a frequency counter to TP2 and set R33 for a frequency 12.8 kHz (period on oscilloscope of 78 uSec).

() Check for a 10v pk-pk square wave at U4 pins 3, 4, 5 and 6. The frequency should be 1600 Hz (period on oscilloscope of 625 uSec).

() The LOCK LED and LEVEL bar graphs should be off.

() The TUNE bar graph should have its 5th LED from the left on. This may vary a bit, but whichever LED is lit represents the actual center frequency indication for your particular PLL and LM3914 combination. You may want to mark this LED position on your front panel for future reference.

() Inject the audio signal again and note that, as you set it near 1600 Hz, the LOCK LED will blink at a rate indicating how far from a 1600 Hz "zero-beat" the input signal is.

() Remove the jumper at JP4.

() Note that the LOCK LED stays on as signal frequency is swept about 1600 Hz. This should be true for at least +/- 150 Hz.

() You should be able to run the TUNE display from off the left end of the scale before LOCK goes out, to (but not beyond) the far right end of the scale by varying the input signal frequency. Thus, lock should be obtainable over the full range of the TUNE display, with the exception of the extreme right LED.

() Connect an oscilloscope or voltmeter to the Main board pad marked "RXD" (or U16 pin 8).

() Connect and disconnect the audio tone several times. Note that the level at "RXD" is sometimes +5v and sometimes 0v when the input tone is present.

() Remove the audio tone.

The next steps deal with calibration of the PSK mode clock generator.

() Place switch S2 in the "PSK" position (DOWN, connects Main board pads 1 and 4).

() Install a push-on jumper at JP7 and set R6 for about 300 mV pk-pk triangle wave at the ungrounded end of JP8.

- () Remove the jumper at JP7 and connect the ungrounded end of JP8 to the receive audio input (center pad of JP3).
- () Verify that the 8th or 9th LED on the LEVEL indicator is lit. If it is not, increase the setting of R6 until it is.
- () Preset trimpot R80 20 turns clockwise.
- () Adjust R80, turning the adjustment screw slowly counterclockwise, until the TUNE indicator bar graph LED is centered (proper LED was determined above) and LOCK LED is on.
- () Place a push-on jumper at JP4 and fine tune R80 for a slow flash rate of the LOCK LED (zero beat). This may be several turns from the apparent centered indication obtained in the previous step.
- () Remove the push-on jumper at JP4.

The next steps in this section check out the AFC (up/down tuning) logic and calibrate it.

- () Preset trimpot R61 by turning its adjustment screw 20 turns clockwise, then back 8 turns counterclockwise.
- () Connect the oscilloscope to Main board pad 21.
- () Inject an audio tone at the PLL center frequency of 1600 Hz.
- () Increase the frequency of the applied tone until pulses are observed (typically at a 5 to 10 Hz rate).
- () Connect the oscilloscope to Main board pad 23.
- () Note that no pulses are present.
- () Reduce the frequency of the applied tone until pulses occur.

Check the tuning step size of the radio you intend to use with the modem. Most modern UHF receivers tune in steps of 10 or 20 Hz, although some tune as coarsely as 100 Hz.

Set the AFC "Dead band" as follows:

- () Inject an audio tone of 1630 to 1640 Hz (1670 to 1680 Hz if your radio tunes in 100 Hz steps).
- () Adjust R61 until pulses just start at pad 21.
- () Connect the oscilloscope to pad 23 and reduce the applied signal frequency until pulses appear.

() Verify that the "Dead band" (the range at which no pulses appear at either pad 21 or 23) is at least as wide as the tuning step size of your radio.

NOTE: The dead band may not be exactly symmetrical about the center frequency of the PLL. This is not important. What is important is that the dead band is at least as wide as your radio's tuning step size and that "step up" pulses begin at a frequency ABOVE the center frequency of the PLL and "step down" pulses begin at a frequency BELOW the center frequency of the PLL.

() Repeat the above three steps until the condition noted immediately above is satisfied.

This concludes the tests and adjustments prior to TNC interfacing.

INTERFACE BOARD CONSTRUCTION

NOTE: The Interface PC board is unusual in that the silk screen and solder mask are both on the solder side of the PC board - no components or wires are mounted on the silk screen side.

Check the PC board and verify that the exposed, tinned pads are clean and shiny. If they are not, scrub the board lightly with a household cleanser (such as "Ajax" or "Comet") and rinse with clean water, then dry with a soft towel.

() PC board clean.

() Solder the 20-pin female header to the Interface PC board.

See Fig. 9, below, for clarification regarding cable preparation and connection in the following steps.

() Using the 6-foot length of shielded cable, strip the outer insulation back a total of 2" (5 cm) from one end.

() Peel the foil shield off, leaving about 1/8" (3 mm).

() Twist the strands of the shield wire tightly together.

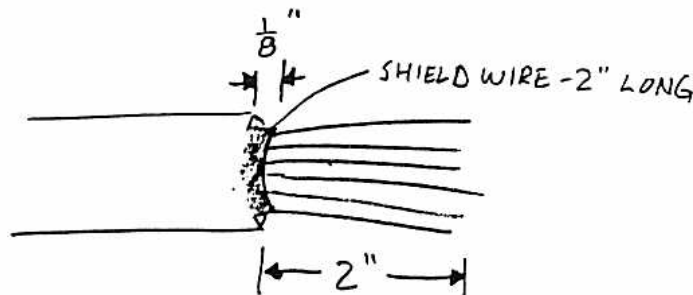

Fig. 9 - Interface Cable Preparation

NOTE: The cable is installed on the same side of the PC board as the connector just installed.

() Wrap the shield wire through holes as shown in Fig. 10. The fit is very tight, but the wire will go through the indicated hole twice! You may want to enlarge the hole slightly with a small drill bit or a knife (it isn't plated-through).

() Be sure the shield wire is wrapped snugly around the cable's foil shield (not the various wires' insulation, or there may be a problem!).

() Solder the shield wire in place at both hole locations.

() Using a piece of insulated hookup wire (a 2" or so piece from the cable will do - be sure the insulation isn't the low-temperature type that melts when you attempt to solder!) and solder one end to the board as shown.

() Twist the strands and tin them.

() Pull the other end tightly over the shielded cable and solder it in place - be careful not to melt the insulation.

In the next few steps, the cable wires will be soldered to the PC board. Trim each wire to fit, and solder one before trimming and soldering the next. Try to keep each wire as short as practical and dressed snugly against the PC board. Install them in the order shown, and route the longer ones as shown.

- () BROWN wire to Pad 1
- () ORANGE wire to Pad 3
- () BLUE wire to Pad 6
- () WHITE wire to Pad 8

NOTE: Pay very careful attention to lead dress for the following wires. They must be snug against the 20-pin header if the pcb assembly is to fit in a shrouded male header such as used in the TAPR TNC 1.

- () YELLOW wire to Pad 4
- () GREEN wire to Pad 5
- () BLACK wire to Pad 7
- () RED wire to Pad 2

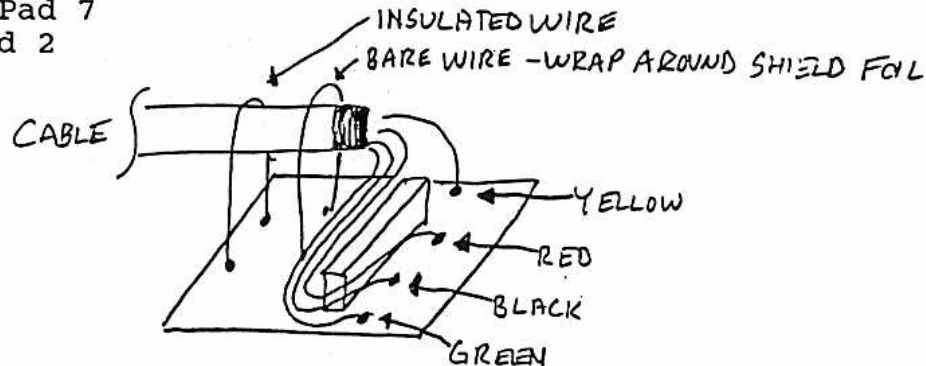

Fig. 10 - Interface PC Board to Cable Wiring

In the next few steps, the 8-pin DIN connector will be installed on the other end of the Interface PC board cable. DIN connectors are a pain to assemble, but be patient and work carefully.

NOTE: DIN CONNECTOR PINOUTS ARE ARRANGED IN A STRANGE WAY - BE SURE YOU GET IT RIGHT! THERE ARE TWO KINDS OF 8-PIN DIN CONNECTORS SOLD, AND ONLY ONE OF THEM IS THE RIGHT ONE (SWITCHCRAFT 15BL8M OR EQUAL).

Detailed instructions are not given here for the connector assembly. However, for the Switchcraft 15BL8M connector supplied with the kit, the following order of wiring is recommended:

- () Slide the rubber cable boot on the cable.

() Solder the wires to the connector pins as follows:

- () WHITE wire to pin 8
- () BLACK wire to pin 7
- () BLUE wire to pin 6
- () BROWN wire to pin 1
- () ORANGE wire to pin 3
- () GREEN wire to pin 5
- () RED wire to pin 2
- () YELLOW wire to pin 4

() Check all the wires and make sure each goes to the proper pin, there are no shorts, and no wires are loose (bad or unsoldered joint).

() Solder the shield to the connector frame, then crimp the frame onto the cable to act as a strain relief.

() Double check all the wiring and make sure there are no shorts or open connections.

() Slide the rubber boot over the completed connector assembly.

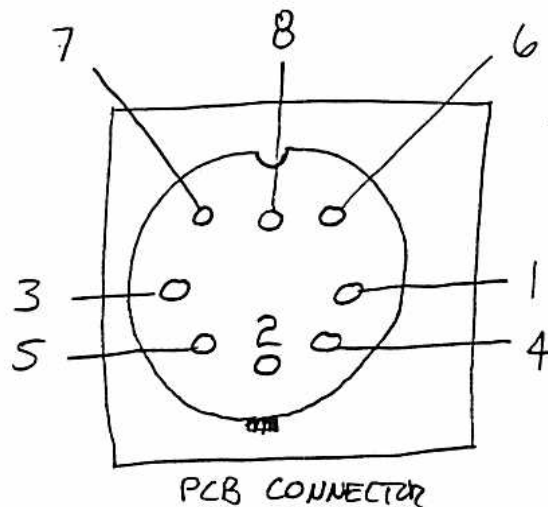

Fig. 11 - 8-Pin DIN Connector Pinout

TNC HEADER INSTALLATION

The next steps will be concerned with connecting the Interface PC board to the TNC. For all TNCs, perform an analog loopback test to verify that the TNC is operational. This test is documented in the TNC 2 manual. For the TNC 1, simply route the mic audio output to the receive audio input and do a self-connect (you may have to increase the TNC 1 modem output level for the loopback test).

NOTE: The supplied shielded cable is 6-feet long. This is probably more than ample for most requirements. Since you will have to make a TNC-to-PSK modem cable from your TNC's RADIO port as well as the modem disconnect, you may want to cut the cable in half and use the remaining piece to fabricate the other required cable.

TNC 2 REV1 and REV2

Perform an analog loopback test to verify TNC operation.

- () Remove the TNC 2 from its cabinet.
- () Install JMP7 on the TNC 2.
- () Apply power to the TNC.
- () Connect to yourself.
- () Disconnect from yourself.
- () Remove power from the TNC.

Now, perform the modifications necessary to interface the PSK modem to the TNC 2.

- () Install the 20-pin male header at J4 (between JMP10 and U21).
- () Cut the trace on the Interface PC board at location JP200. JP200 is the two unlabelled pads between pads 1 and 8 on the Interface PC board.

On the bottom (solder side) of the TNC 2 PC board:

- () Cut the trace at J4 which ties together pins 1 and 2.
- () Cut the trace at J4 which ties together pins 17 and 18.
- () Place a push-on jumper at J4 pins 1 and 2.
- () Place a push-on jumper at J4 pins 17 and 18.
- () Apply power the the TNC.
- () Connect to yourself.

- () Disconnect from yourself.
- () Remove power from the TNC.
- () Remove the jumper at JMP7.
- () Carefully fold Q14 towards U17 to provide clearance for the Interface PC board.
- () Carefully bend C45 towards the outer edge of the TNC PC board to provide clearance for the Interface PC board.
- () Insert the Interface PC board onto the TNC 2 at J4, routing the cable away from U21.
- () Route the cable back between the Radio (DIN) and Serial Port (DB25) connectors. You will probably have to file the metal away above the RS232 connector at the end near the radio connector to allow the cable to exit.
- () You may want to leave off the back panel (but not the bezel) for the remainder of the modem testing procedures.
- () You may also want to leave the TNC out of its case for further testing until the PSK modem is verified. If you do this, remember to use the clip-on heat sink provided with the TNC 2 kit and attach it to the LM7805 regulator on the TNC (TNC 2 Rev 2 boards only).

TNC 1 REV 2 and REV 3

The modem disconnect header already exists at J5 (near U17, HDLC controller).

- () Verify that the TNC is operational.
- () Remove power from the TNC.
- () Ensure that jumper JP200 is intact on the Interface PC board. This is the trace that shorts the two unlabelled pads between pads 1 and 8.
- () Replace R79 (near U17) with a jumper wire on the TNC 1 PC board.
- () Remove the various push-on jumpers at J5.
- () Insert the Interface PC Board onto the TNC 1 at J5, with the cable routed away from U17.

BOTH TNC 1 AND TNC 2

() Insert the 8-pin DIN connector from the Interface PC board cable into the 8-pin DIN receptacle at J1 on the PSK Modem PC board.

RADIO PORT WIRING

The next few steps are not detailed instructions, but indicate the interwiring needed between the TNC Radio port and the PSK Modem TNC connector at J2. Guidelines are given for both TNC 1 and TNC 2 users.

TNC 1 RADIO PORT WIRING

The TNC 1 uses a DE-9 style connector for radio interfacing. The PSK modem uses a 5-pin DIN connector, J2. A mating connector for J2 is supplied; a mating connector for the TNC is not included in the PSK Modem kit. Using shielded cable, construct an interface per the table below:

TNC 1	Function	PSK Modem
5	Mic Audio	1
6-9	Common	2, Shield
4	Push To Transmit	3
3	Receive Audio	4

TNC 2 RADIO PORT WIRING

The TNC 2 uses a 5-pin DIN connector for radio interfacing. The PSK Modem TNC connector uses an identical connector, with an identical pinout. Included in the kit is a mating connector for PSK Modem connector, J2; a mating connector for the TNC radio port is not included. Using shielded cable, construct an interface per the table below:

TNC 2	Function	PSK Modem
1	Mic Audio	1
2	Common	2, Shield
3	Push To Transmit	3
4	Receive Audio	4
5	RF DCD	5

NOTE: RF DCD is simply passed through the PSK Modem. Its use is not required.

NOTE: The required cable may be obtainable as a stereo accessory from various audio shops or Radio Shack.

BOTH TNC 1 AND TNC 2

- () TNC Radio Port to PSK Modem TNC Port cable constructed and checked.
- () Connect the TNC Radio Port to PSK Modem TNC Port cable between the associated TNC and the PSK Modem.

INITIAL TESTING WITH TNC

- () Place 3PDT switch S4 in the "OFF" position (DOWN, shorting Main PC board pads 7-8, 15-16 and 17-18).
- () Put the TNC in analog loopback mode (xmit audio out to rcve audio in).
- () Connect to yourself.
- () Disconnect from yourself.

If successful, this verifies that the Modem Interface header and DIN cable are probably installed correctly.

INITIAL PSK LOOPBACK TEST

- () Apply power to the PSK modem and TNC.
- () Place 3PDT switch S4 in the "ON" position (UP, shorting Main PC board pads 5-8, 11-17 and 13-15).
- () Place SPDT switch S2 in the "PSK" position (DOWN, shorting Main PC board pads 1-4).
- () Temporarily connect a wire from JP3-2 (center pad) (or S1 center lug) to the ungrounded end of JP8. This connects the PSK modulator output to the demodulator input.
- () Command the TNC to FULLDUP ON.
- () Connect to yourself.
- () If successful, this verifies the PSK modulator and demodulator function.
- () Disconnect from yourself.
- () Place switch S2 in the "MAN" mode (UP, connects Main board pads 4 and 3 for TNC 2, or pads 4 and 2 for TNC 1).
- () Connect to yourself.
- () The tuning indicator will show the signal to be at the low end of its tuning range, but the data recovery and LOCK functions should continue to perform satisfactorily.
- () If successful, this verifies the manchester modulator. Disconnect from yourself, remove power from the PSK modem and TNC, and proceed to the **Radio Interfacing** section of this manual.
- () If the loopback test in the MAN position of the switch was not successful, perform the following steps.
- () Verify that a 1200 Hz clock signal is present at U21 pin 6. If not, recheck wiring of S2 to be sure you selected the correct pad (2 for TNC 1 or PK232, 3 for TNC 2) for the TNC you are using.
- () Connect a frequency counter to TP2.
- () Install a push-on jumper at JMP4.
- () Turn the adjustment screw of trimpot R33 counterclockwise to obtain a reading of 9600 Hz, or as low as it will go, whichever is higher.

NOTE: If the lowest frequency obtainable is much higher than 9600 Hz, you may not be able to do a loopback in manchester mode. If this is the case, replace R32 (22K) with a larger value resistor (27K or 33K).

- () Remove the jumper at JMP4.
- () Connect to yourself.
- () The tuning indicator will show the signal to be at the center or low end of its tuning range, depending on the adjustment range of R33. The data recovery and LOCK functions should perform satisfactorily.
- () If successful, this verifies the manchester modulator.
- () If not successful, look in the **Troubleshooting** section of this manual for some guidelines.
- () Disconnect from yourself.
- () Place a push-on jumper at JMP4.
- () With a frequency counter at TP2, adjust R33 for a reading of 12.8 kHz.
- () Remove the jumper at JMP4.
- () Remove power from the PSK modem and TNC.

The next steps deal with interfacing the PSK modem to your radio(s) and their operation together.

RADIO INTERFACING

In addition to the information presented here, check the Specific Radio Interfacing section of this manual for additional data.

VHF Radio Port

If you are using a TNC 2, the existing radio-to-TNC cable may be used between your VHF radio and the PSK Modem's VHF Radio connector, J3.

If not, or if you wish to make another interface cable, wire up a 5-pin DIN connector (supplied with the kit) as follows:

DIN Pin	Function	Comments
1	Mic Audio	To Transmitter
2	Common	Audio Common
3	PTT	Provides TNC's PTT signal
4	Rcve Audio	From Receiver
5	RF DCD	Not usually used

The usual TNC-to-radio interfacing considerations apply here, such as use of shielded cable and tying the cable shield to the DIN connector frame. Consult your TNC manual for further details. Consult your radio's manual for information on connectors and pinout that apply to it.

UHF Radio Port

The UHF radio connector, J4, is a 5-pin DIN. The pinout, however, is unlike that of the VHF port. For some radios, such as the Yaesu FT726R, this connector will tie in to the same connector at the radio end as the VHF radio port.

NOTE: The VHF and UHF connectors are physically identical! While swapping them probably won't damage your radio(s), it will result in improper operation of the Modem.

DIN Pin	Function	Comments
1	Common	AFC Command common
2	Audio Gnd	Audio Common
3	Step Down	AFC Command to radio
4	Rcve Audio	From Receiver
5	Step Up	AFC Command to radio

As can be seen, the primary function of this connector is to provide the AFC command interface. In some cases, it will also provide the receive audio signal, based on the position of switch S1.

Jumpers JP5 and JP6 must be configured to provide the AFC signals required by the radio to be used. Push-on jumpers may be employed, or wire-wrap techniques may be used.

The two most common UP/DOWN interfaces for the digital AFC are shown below.

For radios that require a contact to GROUND to activate the UP or DOWN function (such as the Kenwood TS811A), configure JP5 and JP6 like this:



Fig. 12 - Digital AFC for GROUND-activated UP/DOWN

For radios that require a contact to +5V to activate the UP or DOWN function (such as the Yaesu FT726R), configure JP5 and JP6 like this:

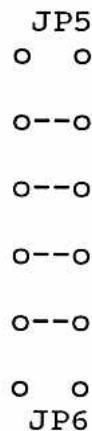

Fig. 13 - Digital AFC for +5V-activated UP/DOWN

As with all modem/radio interface cables, this one should be shielded, with the shield tied to the DIN connector frame at the modem end. Check your radio manual for connector and pinout information.

SPECIFIC RADIO INTERCONNECTS

This information below was gathered from reports sent in by the folks who built the prototype and first kit PSK modems.

Kenwood TS711A/811A

The connections for the Kenwood TS711 and 811 are given below. In addition, these same connections apply if you are using a TS440 or 940 along with a transverter or receiving converter. Except for the 13-pin DIN connector option, the same connections also apply to the TS430 and a transverter or receiving converter. Other Kenwood radios, such as the TR9000 and TR9100, use the same JMP5/6 configuration.

J3		8-pin MIC	Ext Spkr	13-pin DIN
1	Tx Audio	1		11
2	Ground	7	Shell	4,8,12
3	PTT	8		13
4	Rx Audio		Tip	3
5	RF DCD	(n/a)		

J4

1	AFC Common	7	
2	Ground	7	Shell
3	AFC Down	3	
4	Rx Audio		Tip
5	AFC Up	4	

JMP5, JMP6 - see Fig. 12, page 43.

Yaesu FT726R

The same JMP5/6 connections apply to other Yaesu models such as the FT790R.

J3		8-pin Mic	Ext Spkr
1	Tx Audio	8	
2	Ground	7	Shell
3	PTT	6	
4	Rx Audio		Tip
5	RF DCD	(n/a)	

J4

1	AFC Common	
2	Ground	
3	AFC Down	3
4	Rx Audio	
5	AFC Up	1

JMP5, JMP6 - see Fig. 13, page 43.

ICOM Radios

Some ICOM models incorporate amplified microphones. These radios will typically require more drive than usual.

ICOM radios have an odd UP/DOWN arrangement, utilizing a 470 ohm resistor between the UP and DOWN inputs. The following hookup has been reported to work with the IC-490, IC-471 and IC-475 70 cm radios.

Wire JP5 and JP6 as follows:

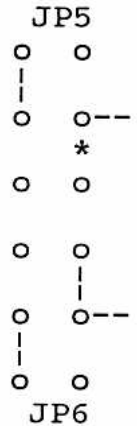

* Connect a 470 ohm resistor between these two pins.

Fig. 14 - ICOM Interface

NOTE: If the microphone is left connected, the resistor may already be in place through the microphone connections. If you elect to put the resistor inside the PSK modem, you may have to disconnect the microphone.

Wire up the UHF radio AFC connections as follows:

J4		ICOM Mic	Ext Spkr
1	AFC Common	6	
2	Ground		Shell
3	AFC Down		
4	Rx Audio		Tip
5	AFC Up	3	

The AFC UP pin now controls both up and down functions.

FINAL CHECK-OUT

- () Connect the VHF radio cable to the 2-meter transceiver.
- () Connect the UHF radio cable to the 70-cm receiver.
- () Place switch S4 in the "OFF" (DOWN) position.
- () Apply power to the TNC, VHF radio and computer/terminal.
- () Establish contact in the normal manner.

At this point, the VHF radio interface is confirmed, and your packet station is capable of normal operation.

The next steps will require the assistance of another PSK equipped packet station in direct communications range (can't use AFSK/FM digipeaters) which can send you a strong signal. You will be performing some "eye pattern" testing and getting the PSK Modem matched up to your station radio equipment for PSK operation. Both stations must use SSB radios.

NOTE: The following calibration is for terrestrial PSK use. If you intend to operate only on satellite, these steps are not necessary. However, if these steps are not performed, initial satellite reception may be more difficult. Please read through this section even if you choose not to perform the PSK calibration steps outlined.

- () Place switch S1 in the "JOINT" (UP) position.
- () Place switch S2 in the "PSK" (DOWN) position.
- () Place switch S4 in the "ON" (UP) position.
- () Connect the oscilloscope vertical input to test point TP1.
- () Connect the oscilloscope trigger input to pad "RXD".
- () Get the other station to send a series of frames, preferably fairly long with little time between them. This is a valid use for Beacon Every 1! Just be sure you are on an otherwise clear frequency! If the other station is TNC 2 equipped, ask him to disable his transmitter watchdog timer, place his unit in CAL mode and send the Dotting pattern.

NOTE: Be sure the other station is not overdriving his transmitter. PSK is a linear mode!

() Twiddle your USB/LSB selector, passband tuning, BFO, and any other controls your receiver has for the best "eye pattern" on your oscilloscope. Things to look for include maximum "eye" opening and minimum jitter in the data edges. See Fig. 15 (on the next page) for "typical" eye patterns.

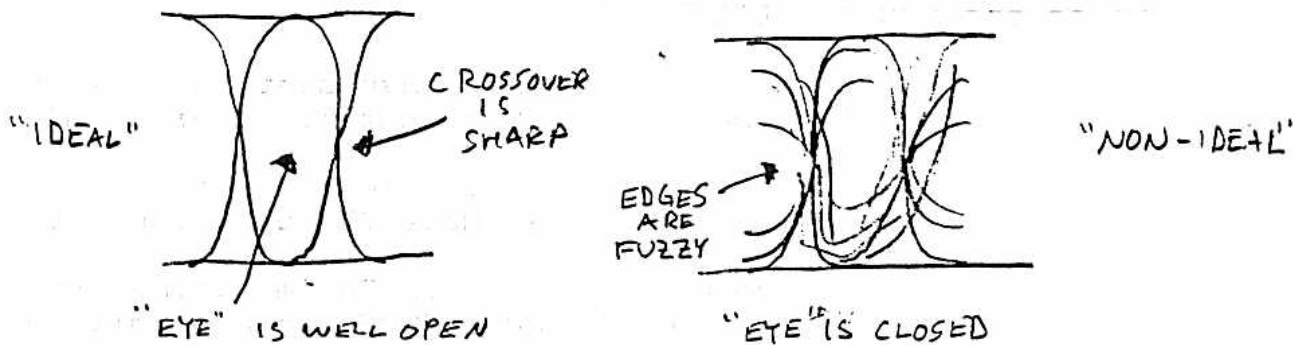

Fig. 15 - Eye Pattern

() Have the other station vary his PSK carrier frequency (typically 1600 Hz) and repeat the adjustments. The eye pattern will be affected by the other station's transmitter characteristics as well as by those of your receiver.

() Once you have your receiver set for best eye pattern, reverse the procedure and send to the other station.

() While sending, and after the receiving station has adjusted things for best pattern, vary your 1600 Hz tone frequency, and try both sidebands (LSB and USB, not DSB) to determine the best settings for your transmitter.

() Once you know the settings for your transmitter, don't vary them. You are already set as good as you can be.

While the above may sound complicated and somewhat tedious, the sad fact is that data transmission requires certain filter characteristics not normally important for voice work. Such factors as phase shift and group delay come into play here. The filters in Amateur transceivers were selected for voice work, and locating the right spot in the filter passband for good data operation is tedious, but necessary.

The next four steps are not strictly necessary, but are very helpful.

() Now, get the other station to move to 70 cm for digital AFC check-out.

() If you are using a different receiver for 70 cm reception, repeat the above steps, then proceed.

() Once you are copying the other station's signal, get him to tune his transmitter slowly off frequency while transmitting data to you. Note that the TUNE indicator LED begins to "move."

() Set PSK Modem switch S3 to the USB position and note whether your receiver steps in the correct direction to follow the other station, or the opposite direction. If opposite, set S3 to the LSB position.

() Perform the same service for the other station, transmitting on 70 cm and allowing him to check out his digital AFC.

() Using whatever tracking means you normally employ, get your station set up to copy the next Mode JD satellite pass.

() Tune in the downlink signal on 70 cm, using the center-tune feature of the PSK Modem **TUNE** bargraph display, and set receive signal level so the 6th or 7th LED in the PSK Modem **LEVEL** bargraph is illuminated when the satellite is transmitting.

() Experiment with sideband selection (USB or LSB) on your receiver for best data recovery. This should be the same as you found with the point-to-point terrestrial tests, above.

() Once **LOCK** is indicated, place S3 in the USB or LSB position, as required, to track the doppler shifted downlink signal.

Your PSK Modem is now checked and calibrated!

At this point, you may assemble you modem into its case (see next section), install your TNC into its case, etc.

And, please, send in your comments about this manual as well as any suggestions you may have, to the TAPR office. Your experiences will help us help others get involved in PSK packet operation.

RADIO SHACK CABINET INSTALLATION

If you wish to use the provided front panel and rear panel "stick-on" labels and use the Radio Shack 270-252, a Mouser 40UB102 or the optional TAPR cabinet, the following guidelines may be helpful.

- 1) It is recommended that the builder use a decimal inch tape or ruler calibrated in 100ths of an inch. Sears sells a 6" rule that is especially handy for this work. All measurements on the attached drawings are in decimal inches.
- 2) Remove cabinet top and feet. Place main modem circuit card in cabinet bottom centered between the side flanges and press DIN sockets against back panel. Mark holes for standoffs with an ice pick or center punch.
- 3) Drill standoff holes with #32 drill bit and debur holes with a larger drill.
- 4) Use templates provided to drill front and back panels. Be careful and use sharp tools and bits. The aluminum is **VERY** soft -- it can be cut with scissors. A metal nibbler is especially handy for making the rectangular cutouts for the LED bargraph displays. A drill and file would work just as well. Trial fit the display circuit board to get the fit just right.
- 5) Mount standoffs (Radio Shack p/n 276-195) with hardware provided (with standoffs). Use small lockwashers between the standoff and the cabinet to prevent turning of the standoff after the unit is assembled. The display board may be mounted with 1/4 inch standoffs or spacers, or even a small stack of washers (may be longer if you use IC sockets), to the front panel with 6-32 hardware. If you installed JP100, you may find it gets in the way in this cabinet. Remount feet to cabinet. You may have to slightly notch the rubber feet with side cutters to provide space for the standoff screws. An alternative is to use stick-on feet and reposition the feet so they do not interfere with the standoff screws.
- 6) Power connector (Radio Shack 274-1716 or 274-1565) should be mounted to cabinet back below circuit card using hardware provided with the connector. Switches and control should be mounted to the front panel after they are wired to the circuit card with ribbon cable.
- 7) The fit is pretty tight in this cabinet, so work carefully!

OPERATION**FSK (NORMAL)**

For normal packet operation with your TNC's internal modem, place switch S4 in the "OFF" position. The settings of the other switches will have no effect. The PSK modem need not be powered up in this mode.

All cables (except the UHF radio, J4) must be connected between the TNC, PSK Modem and VHF radio.

Operation will be the same as before the TAPR PSK Modem was installed.

If you wish to restore the TNC to normal operation without having the PSK modem in line, be sure to place jumpers in the TNC's modem disconnect header. (For TNC 1, jumper pins 1-2, 5-6, 7-8, 9-10, 11-12, 13-14, 17-18 and 19-20; for TNC 2, jumper pins 1-2 and 17-18).

PSK (TERRESTRIAL)

For PSK use, as in point-to-point terrestrial, or weak signal work, set the switches as follows: S1 - JOINT, S2 - PSK, S3 - OFF, S4 - ON.

Once contact is established, you may want to activate digital AFC via switch S3. This would only apply if you expect that either your receiver or the other station's transmitter may drift off frequency.

Tune in the desired signal using the center-tune feature of the PSK Modem **TUNE** bargraph display, and set the receive signal level so the 6th or 7th LED in the PSK Modem **LEVEL** bargraph is illuminated when the other station is transmitting.

Set the drive level to the associated SSB transmitter so that overdrive or "flat topping" does not occur. Keep in mind always that PSK is a **linear** mode, not a limiting mode as with FSK.

If you haven't already done so, set the PSK modulator tone frequency for best operation with your transmitter passband. If this is not known, or you lack the equipment to make the measurements (see **FINAL CHECK-OUT**, above), set this frequency to 1600 Hz.

Since NRZI is polarity insensitive, use the sideband (USB or LSB) position on your receiver that you determined to be best in the **FINAL CHECK-OUT** procedures.

Operation will be as with traditional packet in all other respects.

Satellite

For MicroSat/FUJI use, set the switches as follows: S1 - SPLIT, S2 - MAN, S3 - OFF, S4 - PSK. (If you are using an FT-726, set S1 to JOINT.)

Please read completely through this section before attempting to operate via packet satellite.

Tune in the downlink signal on 70 cm (published frequency +/- doppler - about 8 kHz peak), using the center-tune feature of the PSK Modem **TUNE** bargraph display, and set the receive signal level so the 6th or 7th LED in the PSK Modem **LEVEL** bargraph is illuminated when the satellite is transmitting.

Experiment with sideband selection (USB or LSB) on your receiver for best data recovery. Once **LOCK** is indicated, place S3 in the USB or LSB position as required to track the doppler-varying downlink signal.

Set the drive level to the associated two-meter FM transmitter so that deviation limiting does not occur. It has been found that 2.8 to 3.0 kHz deviation on the high tone is optimum for terrestrial AFSK/FM packet use, and there is no data that we are aware of to suggest that the satellites require anything different. Establish contact with the satellite on one of the two-meter FM uplink channels, using the satellite callsign. All uplink channels are usually active whenever the satellite is in Mode JD. The multiple input channels are a form of contention reduction. The satellites automatically allow for doppler from earth stations, so you do not need to adjust your transmit frequency as the satellite passes over.

NOTE: Mode J operation (2 meter uplink and 70 cm downlink) places stringent requirements on the station receiver, transmitter and antenna system, since the third harmonic of the station transmitter may fall in the passband of the receiver, resulting in desense and/or distortion of the received downlink signal. You may need to place a cavity or other filter in the receive and/or transmit feedline to correct for this.

Once contact is established with the BBS, or with a ground station via the satellite's digipeating facility, operate in accordance with published operating information.

The following information is intended to act as a guide to typical satellite operation. It is based on the FUJI-OSCAR 12 BBS operation. While FO-12 is no longer operational, the MicroSats and FO-20 will likely be similar. Check with AMSAT for details 9AMSAT, PO Box 27, Washington DC 20044.

The satellite's callsign was:

8J1JAS

FUJI Commands

The available commands for the FUJI BBS are:

```

B      : List file headers addressed to ALL
F      : List latest 10 file headers
F*     : List all file headers
F<d>   : List file headers posted on day <d>
H      : Show this message
K<n>   : Kill a file numbered <n>
M      : List file headers addressed to current user
R<n>   : Read a file numbered <n>
U      : List current user(s)
W      : Write a file

```

The general format of sending commands to FUJI is:

```
<COMMAND> <SPACE> <ARGUMENT>
```

where:

<COMMAND> is any valid command listed above,

<SPACE> is simply a blank space,

<ARGUMENT> is a required or [optional] additional character or string of characters for the command.

FUJI will prompt you after you connect to it with:

```
JAS>
```

This is your indication that the satellite is ready to accept commands from your station.

The commands are summarized below, followed by an sample session. After you have monitored a pass or two, so that you have familiarized yourself with tracking, tuning and the satellite BBS operation itself, try connecting and join the fun!

Bulletin

B command (B = Bulletin)

Show file headers addressed to "ALL". You can look for bulletins or general information without having to sort through lengthy listings of personal message headers addressed to various users.

Files

F command (F = Files)

Use this command to list file headers. The following arguments apply:

F (no argument)

List the latest 10 messages (files). Subsequent issuing of this command with no argument will list the next 10 files, etc.

F * (asterisk)

List **all** file headers in the FUJI BBS.

F d (d = day, use a number between 1 and 31)

List all file headers posted to the satellite on the day specified. The month or year cannot be specified. For example,

F 9

would list all files posted to the satellite on the 9th day of any month.

Help

H (H = Help)

If you send an "H" to the satellite, it will respond with a list of valid commands:

++ Available commands ++

B : List file headers addressed to ALL
 F : List latest 10 file headers
 F* : List all file headers
 F<d> : List file headers posted on day <d>
 H : Show this message
 K<n> : Kill a file numbered <n>
 M : List file headers addressed to current user
 R<n> : Read a file numbered <n>
 U : List current user(s)
 W : Write a file

Kill

K n (K = Kill, n is the number of the message)

Use this command to delete messages from the satellite. Messages must be specified by number (up to eight numbers can be specified when issuing the command). Only the sender or the recipient can kill messages. Only the sender can kill messages addressed to more than one user, or addressed to ALL.

The message number to use is the one sent by the satellite in response to an "F" or "M" command.

Mine

M (M = Mine)

This command will cause the satellite to send you a list of file headers addressed to or from your station. It is useful if you want to scan for your personal messages quickly.

The first time you use it on a pass, the most recent 10 message headers will be displayed. Subsequent issuing of this command will show the next 10 most recent, etc.

Read

R n (R = Read, n is the number of the message)

This command allows you to read any message listed by the F command. If the message is addressed to you only, it is good practice to follow the Read n by a Kill n to conserve memory space onboard the satellite.

Users

U (U = Users)

Issuing this command will result in your being sent a list of callsigns of all users currently logged on the mailbox. The SSIDs will not be displayed. This command is useful to help you set your FRACK and MAXFRAME parameters (extend FRACK and reduce MAXFRAME the busier the satellite becomes). It also gives you an idea of channel loading, etc.

Unlike most BBSes, FUJI is a multi-user system, so several (up to 16) other stations can access the system at the same time.

Write

W (W = Write)

This command will put you into the message (file) loading mode. FUJI will prompt you for the recipient of the message (one, two, or more users, up to eight, may be specified). The recipient will be "ALL" if no recipient is otherwise specified.

FUJI will next prompt you for a subject (Subj:) - this may be a string of up to 32 characters and will help others in identifying the contents of your message.

You will then be prompted for the text (Text:) of the message.

A single line of a period (.) or control-z (^Z) will end the uploading of the message. That is,

<CR>.<CR>

or

<CR><^Z><CR>

Operation Example

The example of operation below was provided by the JAMSAT software team at the time of release of FUJI BBS software version 1.10. The TNC command syntax is that of the WA8DED TNC software.

```
* i
* JR1FIG *
* c 8j1jas
```

```
* (1) CONNECTED to 8J1JAS *
```

```
FO-12/JAS-1 Mailbox ver. 1.10
commands [B/F/H/M/R/U/W]
Use H command for Help
```

```
JAS>h
```

```
++ Available commands ++
```

```
B      : List file headers addressed to ALL
F      : List latest 10 file headers
F*     : List all file headers
F<d>   : List file headers posted on day <d>
H      : Show this message
K<n>   : Kill a file numbered <n>
M      : List file headers addressed to current user
R<n>   : Read a file numbered <n>
U      : List current user(s)
W      : Write a file
```

JAS>f

NO.	DATE	UTC	FROM	TO	SUBJECT
054	08/09	10:16	JA2PKI	ALL	TAPR PSK Modem Kit
053	08/09	10:15	JJ1ZUT	ALL	FO-12 Latest Operating Schedule
052	08/09	10:12	JM1MCF	JR1FIG	Hi
050	08/09	10:05	JA2PKI	JJ1ZUT	Want updated operating schedule
049	08/09	10:01	JR1ING	JR1FIG	New Release
048	08/07	06:19	WA8EBM	K7PYK	Hi
047	08/07	06:16	K7PYK	VE1PAC	FO-12
046	08/07	06:11	WA8EBM	KA9LNV	Hi Ed

JAS>f*

054	08/09	10:16	JA2PKI	ALL	TAPR PSK Modem Kit
053	08/09	10:15	JJ1ZUT	ALL	FO-12 Latest Operating Schedule
052	08/09	10:12	JM1MCF	JR1FIG	Hi
050	08/09	10:05	JA2PKI	JJ1ZUT	Want updated operating schedule
049	08/09	10:01	JR1ING	JR1FIG	New Release
048	08/07	06:19	WA8EBM	K7PYK	Hi
047	08/07	06:16	K7PYK	VE1PAC	FO-12
046	08/07	06:11	WA8EBM	KA9LNV	Hi Ed
044	08/07	05:42	ZL2AMD	VK3DTO	hello and thanks
041	08/07	04:55	ZS6IT	ON6UG	Transverter
039	08/07	02:33	ON6UG	ON4DY	HI
038	08/07	02:28	ON6UG	VK3DTO	QSL
037	08/07	02:25	ON4DY	VK3DTO	SRI CRASH
036	08/07	02:23	ON6UG	ZS6IT	Doc 2.4 on the way
035	08/07	02:19	KA9LNV	WB5IPM	HI
033	08/07	02:08	K7PYK	JA1KSO	FO-12
032	08/07	02:07	VE3JF	VK2ZDE	Question
031	08/07	01:34	VK2ZDE	VK5ZK	HI GARRY
030	08/07	01:25	VK2ZDE	ZL2AMD	HI DAVID
029	08/07	01:17	VK3DTO	ALL	SEQTG PART 2
028	08/07	01:14	VK3DTO	ALL	SEQTG PART 1
027	08/07	01:11	VK3DTO	ALL	TNC KIT
022	08/06	05:50	5Z4WB	JR1FIG	Hi Saya!
:	:	:	:	:	:

JAS>f9

NO.	DATE	UTC	FROM	TO	SUBJECT
054	08/09	10:16	JA2PKI	ALL	TAPR PSK Modem Kit
053	08/09	10:15	JJ1ZUT	ALL	FO-12 Latest Operating Schedule
052	08/09	10:12	JM1MCF	JR1FIG	Hi
050	08/09	10:05	JA2PKI	JJ1ZUT	Want updated operating schedule
049	08/09	10:01	JR1ING	JR1FIG	New Release

JAS>m

NO.	DATE	UTC	FROM	TO	SUBJECT
052	08/09	10:12	JM1MCF	JR1FIG	Hi
049	08/09	10:01	JR1ING	JR1FIG	New Release
022	08/06	05:50	5Z4WB	JR1FIG	Hi Saya!

JAS>b

NO.	DATE	UTC	FROM	TO	SUBJECT
054	08/09	10:16	JA2PKI	ALL	TAPR PSK Modem Kit
053	08/09	10:15	JJ1ZUT	ALL	FO-12 Latest Operating Schedule
029	08/07	01:17	VK3DTO	ALL	SEQTG PART 2
028	08/07	01:14	VK3DTO	ALL	SEQTG PART 1
027	08/07	01:11	VK3DTO	ALL	TNC KIT
:	:	:	:	:	:

JAS>u

JJ1ZUT JA2PKI JM1MCF JR1ING JH3BJN JF3KTJ JA8ERE JR1FIG

Ending the QSO

To end the QSO with the FUJI BBS, simply disconnect. There is no "logoff" command.

Protocol Version

Finally, be sure you are using AX25L2 Version 2 protocol (NOT version 1). If you are running a TNC 1, you must use WA8DED software which supports full duplex (version 1.3 or later, see note below).

TNC Parameter Settings

Start with the following parameter settings on your TNC:

TAPR Command	WA8DED Command	Comment
FRACK 6	F6	This is the <u>MINIMUM</u> to use!
MAXFRAME 3	O3	This is the <u>MAXIMUM</u> to use!
FULLDUP ON	@D1	Otherwise, you'll never xmit!

If you use a FRACK of less than 6, you will unnecessarily clog the satellite. Usage of a larger setting, up to the TNC's maximum value of 15, is suggested.

A MAXFRAME setting of 1 may actually help your throughput!

NOTE: WA8DED has made available software that runs in the TAPR TNC 1, TNC 2 and clones. Ron has made this software available to the Amateur packet community at no charge. TAPR has obtained Ron's permission to distribute this software. Contact the TAPR office for details.

THEORY OF OPERATION

The theory of operation of the major systems of the TAPR PSK modem are presented in this section. Detailed theory of PSK modulation, Costas loop operation, etc., are beyond the scope of this section.

Power Supply

Standard linear series-pass regulators are incorporated in the power supply.

Incoming +13 volts is applied to +5-volt regulator VR1. C1, C5 and C6 provide energy storage and help suppress oscillations in the regulator.

A low-forward-drop regulator is used at VR2. Incoming +13 volts dc is applied to the input, and the ground (reference) lead is tied to the +5-volt regulator output. The resulting +10 volts is supplied to the rest of the modem circuitry. C2, C3 and C4 provide energy storage and oscillation suppression.

Input polarity protection is provided by shunt diode D1.

Modulator

The PSK modulator requires two inputs: data and clock.

Data is supplied via U16C, a schmitt trigger to help clean any "dirty" signals from the associated TNC.

A free-running clock (selected in the PSK mode) is generated at twice the desired frequency by oscillator U24, a 555. The output of U24 is divided by flip-flop U17A to provide a 50% duty-cycle square-wave at the desired PSK center frequency, nominally 1600 Hz.

In the MANCHESTER mode (required for satellite operation), the clock from the associated TNC is buffered by U16C and passed to divider U18. The appropriate output of U16 is selected to provide a 1200 Hz clock signal to be passed to the PSK modulator.

In addition, the clock is applied to flip-flop U17B which samples the incoming data. The input and output from U17B is compared in an exclusive-or gate (U21D). At every data edge, a brief (25 uSec or so) reset pulse is applied to divider U18 to assure that the data edges and clock edges are synchronized.

PSK modulator U21 accepts the clock signal on pin 6 and the data signal on pin 5. The resulting output (pin 4) is attenuated by R5/R6, then passed via C7 to lowpass filter R7/C8 before being applied to the associated radio.

Demodulator

The nature of a PSK signal is much like that of a double-sideband, suppressed-carrier signal. As a result, a circuit developed by John Costas of GE in the 1950s for DSB reception is applicable in demodulating a PSK signal.

Basically, the incoming signal is applied to an absolute-value multiplier, consisting of a gate of U1, an op amp section of U2 and three equal-value resistors. When the gate control signal is low, the op amp acts as an inverting, unity-gain (-1) amplifier. When the gate control signal is high, the op amp acts as a noninverting, unity-gain (+1) amplifier. If the applied gate control signal is of the same frequency and phase as the applied signal, the result will be like that of a full-wave rectifier. The "polarity" of the full-wave rectifier will depend on whether the control signal is in phase, or in anti-phase, with the applied signal.

For other phases of the applied signal, the output of the op amp section will be unlike a full-wave rectifier, and the resulting average voltage will thus be somewhere in between the full "positive" and the full "negative" values.

It follows, then, that if the applied signal were +/- 90 degrees out of phase with the applied signal, the averaged output voltage of the circuit would be halfway between the positive and negative peaks, or zero.

Examination of the circuit diagram will show that this is exactly how things are hooked up. The top channel, using op amps U2A and U3A, is driven by a signal that is in phase (or in anti-phase) with the input signal when the system is in phase lock. This channel is generally referred to as the information or I, channel. The second channel, consisting of op amps U2D and U3D, is connected to a signal 90 degrees out of phase with the applied signal. This is the quadrature, or Q, channel.

The amplifiers of each stage in the demodulator are referenced to the analog reference voltage developed by U8D. This is nominally +5 volts. Thus, a "zero" output will correspond to +5 volts, and positive and negative average values will be summed with this +5 volt reference.

The filter sections of the demodulator are second-order, with a cutoff frequency of 900 Hz. If you think of the system as demodulating a DSB signal, then the applied "RF." is 1600 Hz and the gated amplifiers act as mixers to a zero frequency "IF." whose noise response is shaped by the filters for a bandwidth of 900 Hz.

The output of the I channel is the data output, as well as the control signal to another gated amplifier via U8A and a section of U9. The amplifier's other input is the filtered output from the Q channel. The output of this amplifier is fed to integrator U7C, whose output is the control voltage to VCO U6.

If everything is in phase lock, and the input signal is centered at the normal free-running frequency of the VCO, the output of the integrator will be "zero" -- that is, the analog reference, or +5 volts.

If the input frequency is less, the loop will lock at the lower frequency (assuming it is in the capture range of the phase lock loop system). The control voltage to the VCO will not be +5 volts, though, and this information is used to drive the center-tune indicator. Thus, tuning an input signal to center on the tuning indicator will ensure that the loop is locked at or very near its natural frequency.

The VCO output, at 8 times the actual signal's (suppressed) carrier frequency of 1600 Hz, or about 1200 Hz, is applied to divider U5 and shift register U4. This results in a 1200 Hz signal with "taps" from the shift register every 1/8 cycle, or 45 degrees. Thus, U4 provides a precise source of phase-shifted VCO output at the desired frequency and with a precise 50% duty cycle.

There are two other channels in the demodulator, identical to the I and Q channels except they are fed with clocks from the VCO that are 45 degrees ahead of, and 45 degrees behind, the I channel.

As noted above, the filtered output of the gated amplifiers, when everything is in lock, will result in an average voltage that depends on the phase of the gating clock with respect to the applied signal. In the +/- 45 degrees case, a small positive voltage will result at the output of U7A when the loop is phase locked for a period of several milliseconds. U7A output is filtered by R51/C28 and applied to comparator U7B, whose other input is at about +5.1 volts, or 100 mV above the analog reference.

If the filtered output from U7A is a value in excess of this threshold, U7B will go high, providing LOCK indication via U16 to both the front panel and the associated TNC's DCD input, as well as gating the digital AFC circuit as explained below.

Indicators

A sample of the amplified input signal is scaled and rectified by U10B, and the resulting positive-going dc voltage is filtered by R56/C29 before being applied to the LEVEL indicator circuit.

Level indicator U101 is an LM3915, which provides a logarithmic display. Internally, the LM3915 contains a series of comparators. Each comparator has the internal reference voltage applied to one side, and a tapped resistive series divider provides the other signal. The resistive string is connected from ground to the applied input voltage. Decoding logic is enabled or disabled by JMP100 to provide a bar or moving-dot display.

Tuning indicator U103 is an LM3914, whose operation is the same as U101 except that the internal resistive divider string is set up to provide a linear step rather than a logarithmic one. The resistive string is

connected in series with R104 and R103 to expand the resolution of the display about the center point.

Digital AFC

In the UNLOCKed state, U9 applies the analog reference voltage (+5 v) from R77 to the inputs (pins 9 and 12) of comparators U10C and U10D.

With R61 set to provide more than zero ohms of resistance, the other inputs of U10C and U10D (pins 10 and 13) are biased such that the comparator outputs are near 0 volts. This condition results in both oscillators of U11 being held in the reset condition, at which point their outputs are held near 0 volts as well.

In the LOCKed state, U9 is toggled to apply a filtered sample of the VCO control voltage (at the junction of R68 and C35) to comparators U10C and U10D. If the control voltage exceeds that at the junction of R59 and R61, comparator U9D's output will go near +10 volts, enabling oscillator U11A to operate. If the AFC switch is in the USB position, pulses from U11 pin 5 will be applied to optoisolator U12, through the internal LED at pins 1 and 2, and through shaper R75/C48 to ground. The resulting pulses (several per second) at U12 pins 7 and 8 may be applied to the associated radio to tune it in such a manner as to reduce the control voltage to the VCO. When the control voltage falls below the level at the junction of R59 and R61, U10D will go towards ground, disabling the oscillator, and hence the pulses, to the radio.

In a similar manner, if the VCO control voltage falls below that set at the junction of R60 and R61, comparator U10C will enable the other oscillator section of U11, ultimately resulting in tuning pulses to the associated radio to drive the VCO control voltage above that at the junction of R60 and R61.

TROUBLESHOOTING

This section of the PSK Modem manual is intended to be a general guide for troubleshooting the modem. It is impractical to provide a comprehensive, step-by-step guide that would cover all possible situations. Hopefully, you will never have to refer to this section. In the unhappy event that you do, this section should assist you in your troubleshooting efforts.

If you run into a problem that is not helped here, please write to the TAPR office and inform us so that we can share your experience with others.

General

NOTE: Never insert or remove an IC with power applied to the PSK modem!

If you have problems with your PSK modem, the first thing to do is verify that all ICs are seated properly in their sockets. Don't forget to check the IC orientation.

Next, look for obvious mechanical and physical problems. Are any parts burned, or crispy-looking? Have any leads from the bottom of the board pierced any insulation in the front panel wiring? Are all connectors installed properly (the TNC audio, VHF and UHF radio connectors are physically interchangeable...)? Are the switches in their correct position for the mode intended?

After you have satisfied yourself of these areas, the PSK modem has been broken into several functional modules for troubleshooting purposes: power supply, modulator, demodulator, indicators and digital AFC. These areas will now be discussed.

Power Supply

The power supply is straightforward in design. However, we had one board with a hairline trace that shorted the +5 and +10 volt buses together. The trace was invisible, and had to be opened by removing the ICs and applying a storage battery across the buses to evaporate the trace!

Verify that the +5 volt bus is indeed at +4.7 to +5.3 volts DC. Verify that the input voltage is at least +10.8 vdc at the lowest level of the applied power's ripple.

If this is OK, remove ICs U11, U16, U17, U21 and U24. These are the only ICs that operate on +5 volts. Recheck the voltage. If it is still not correct, check D1 (it may be incorrectly marked at the factory), C1, C5 and C6. Finally, replace VR1.

Once the +5 volts is OK, verify that the +10 volt line is in the range +9.4 to +10.6 volts. Again, verify the input voltage at the lowest

ripple voltage level, then pull all ICs except U11, U16, U17, U21 and U24.

Lastly, check capacitors C1, C2, C3 and C4.

Once the +5 and +10 volt lines are verified, install U8 and verify that the analog reference voltage at pin 11 is within 100 mV of the +5 volt line.

Finally, start inserting the ICs and cycling power after each one until the culprit is found. Then, swap this IC with a known good one. If the problem persists, check the circuitry associated with the IC that causes the problem.

Modulator

Verify that +5 volts is present at the power pins of U24, U21, U18 , U17 and U16.

Check U24 pin 3 for a frequency of about 3200 Hz (2000 Hz to 4000 Hz may be OK), and that the frequency can be varied by trimpot R80. Verify that U17 pin 1 is a square wave at 1/2 the frequency noted at U24.

With switch S2 in the PSK position, verify that this square wave is present at U21 pin 6. With the associated TNC off (or disconnected), a square wave of the same frequency should be at U21 pin 4. Verify that the ungrounded end of JP8 has a triangle wave output whose amplitude is adjustable by trimpot R6. Verify that jumpering JP7 greatly increases the amplitude of this signal.

At this point, the PSK modulator is functional.

Next, apply power to the associated TNC and send some data. The data pattern should affect the observed waveform. If it does not, verify that the data is present at U16 pin 5, then at U16 pin 6. If not at pin 5, remove U16 and check again. If still not present, check interwiring to the TNC. If present, replace U16.

Now, verify that the data is present at U21 pin 5. If so, and not at the output, suspect U21.

Next, verify that a clock signal is present from the TNC at U16 pins 3 and 4. Check for clock at U18 pin 1. Place switch S2 in the MAN position, and verify that a 1200 Hz clock is present at U21 pin 4. If it is 600 Hz or 2400 Hz, you are probably wired to the wrong pad at the output of U18.

If there is no clock, check for approximately 0 vdc at U18 pin 2. Pulses are OK if data is being sent. With no data, the voltage should be near 0. Next, send data and observe the reset pulses at pin 2 of U18. If no pulses are present, U16, U17 or U18 may be bad.

Once the above conditions are met, the modulator is functional.

Demodulator

Once the power supply is thoroughly checked, and the modulator performance verified, the demodulator can be dealt with.

First, jumper JP4 and verify that U7 pin 8 is at +5v dc (the same as the value at U8 pin 14 -- the analog reference voltage). Set R33 for for a 12.8 kHz waveform at TP2. The amplitude of this waveform should be 0v at the low end and +10v at the high end. Verify that this same signal is present at U5 pin 1 and U4 pin 8.

Check for a 10v pk-pk 1600 Hz squarewave at U5 pin 9 and U4 pins 1 and 2.

Now, verify that a 1600 Hz (period of 625 uSec) squarewave is present at U4 pin 3 and U1 pin 12. If you have an external trigger input, or a dual-trace, oscilloscope, trigger the display from this point. A 1600 Hz squarewave should be present at U4 pin 4 and U1 pin 13, offset from the trigger by 78 uSec. Similarly, a 1600 Hz squarewave offset by 156 uSec should be present at U4 pin 5 and U1 pin 12, and a 1600 Hz squarewave offset from the trigger by 234 uSec should be present at U4 pin 6 and U1 pin 5.

Remove the jumper at JMP4.

Next, inject a 1600 Hz signal to the demodulator at JP3 pin 2. Set the amplitude until 1v pk-pk is observed at U8 pin 8. The signal at U8 pin 8 should be riding on a dc level of +5v (the signal should be at a dc level of +4.5v at the low-going peak excursion and +5.5v at the positive peak). Verify that this same signal is present at U1 pins 1, 4, 8 and 11.

Connect the 'scope to U2 pins 1, 7, 8 and 14 in succession and verify that the waveform shown on the schematic is present. (The pattern may be inverted with respect to the +5v analog reference.)

If you don't see this waveform, and the LOCK LED isn't on, try to carefully "zero-beat" the input signal with the 1600 Hz signal found on U4 pin 4. The patterns may "drift", but the idea at this point is to verify that the absolute value input circuits (such as that formed by U1A, U2A, R10, R11 and R12) are all functional and fed by a different phase of the 1600 Hz clock provided by U4.

Now, check U3 pins 1, 7, 8 and 14 in succession and verify that the patterns match those on the schematic. Again, they may be inverted with respect to the +5v analog reference.

Verify that U8 pins 7 and 8 are steady, then check U7 pins 1 and 14 for (slightly noisy) dc levels. Similarly, check U7 pins 7 and 8 for steady (but perhaps slightly noisy) levels.

If all is well to this point, the LOCK LED should be on and the center LED of the TUNE display lit. If not, check the display system, as outlined below, before proceeding.

With the indicators properly indicating, connect up a TNC (or a source of 600 Hz squarewaves at the stood-up end of R3) and send flags (TNC 1) or a dotting pattern (TNC 2). Select the PSK modulator and place the unit in loopback mode (ungrounded end of JP8 to JMP3 pin 2). Using a dual-trace 'scope, put channel 1 on the RXD test point and channel 2 at TP1 (stood up end of R15, near U3 pin 1). Trigger the 'scope from channel 1. If you don't have a dual-trace 'scope, hook the vertical input channel to TP1 and the trigger input to the RXD test point.

You should see an eye pattern with characteristics similar to that shown in Fig. 15, page 47. The important thing here is that the slope of the "eye" is about 1 bit period (833 uSec) from the beginning of an "edge" to the tail of the "edge" -- if not, the filter section at U3A is suspect.

Finally, compare the output data (U16 pin 8) with the input data (U16 pin 5). There should not be excessive jitter, and the waveforms may be out of phase, but the relationship between them should be both steady and apparent.

The demodulator is now functional.

Indicators

Once the power supply and demodulator are in known working order, the indicator subsystem can be attacked.

Short the audio input to the demodulator to ground. Verify that there is no signal at pin 8 of U8. Likewise, there should be no signal at pin 7 of U10.

Now, apply an input signal of several millivolts. Monitor U8 pin 8, and you should see the signal level amplified (depending on the setting of the optional input level control). Clip a voltmeter to R55 and note that a dc voltage is present, which increases as the input signal level is increased. The DC level at R55 should correspond to the peak voltage of the applied signal at U8 pin 8, measured with an AC-coupled voltmeter or oscilloscope.

For example, if the measured signal is 2v pk-pk, then the voltage at R55 should be 1 vdc. If it is not, check that U10 pin 7 has a signal on it (it will be clipped and otherwise distorted). If U10 pin 7 is OK, then R55 is open or loaded by a shorted C29 or a short at U101 pin 5 on the display board.

Verify that the +5 and +10 volt buses on the display board are OK.

With a dc voltage of about 2 at pin 5 of U101, the level bargraph indicator, U100, should have its 5th, 6th or 7th LED illuminated.

If not, verify that U101 is in fact the LM3915 (NOT an LM3914). Next, check pin 7 of U101 for a voltage of about +1.2 volts.

At this point, the LEVEL circuitry should be functional.

The LOCK driver is simple. Carefully short U16 pin 11 to +5 vdc. The LOCK LED should illuminate. If it does not, check U16, R101 and D100 - be sure D100 is installed in the proper polarity.

If the LOCK LED works, but LOCK doesn't indicate when the PLL is in fact phase-locked to an incoming signal, check U11 pins 6 and 12 for a 10-v square wave at the input signal frequency (use 1600 Hz). Check U9 pin 13 for a square wave. If not present, check the U2-U3-U8 channel which drives U9 pin 13. In a similar manner, check the U2-U3 sections which drive U9 pin 1.

Digital AFC

First, verify that U10 is a TLC274. A TL084 or other op amp may not be suitable, as the 556 requires a control voltage at pins 4 and 10 that goes very near 0 vdc.

Second, be sure the demodulator is functional. The digital AFC derives its control voltages from the the demodulator's PLL control voltage, so a defunct demodulator will render the digital AFC inoperative.

Inject a signal from a function generator or audio oscillator to the demodulator at a frequency of 1600 Hz and of sufficient amplitude to ensure that the LOCK LED illuminates.

Verify that U9 pin 5 is near +10 vdc and U9 pin 6 is near 0 vdc. If pin 6 is not correct, suspect U10 or R77. If U10 pin 1 is near 0, suspect the PC board. If pin 5 is not correct, and the LOCK LED responds properly, there is a broken circuit trace between U7 pin 7 and U9 pin 5.

Reduce the amplitude of the input signal, or change its frequency, until the LOCK LED extinguishes. The voltages at U9 pins 5 and 6 should now be the opposite of that they were. If not, the same logic applies to isolating the fault.

In the unlocked condition, the voltage at U9 pins 3, 8 and 9 should be essentially that of the +5 volt analog reference. In addition, U10 pins 9 and 12 should match. Verify this. Next, set R61 20 turns counterclockwise, then 10 turns clockwise (center of rotation). Check that U10 pins 8 and 14 are near 0 vdc. Check that that U11 pins 4 and 10 are likewise near 0 vdc, and that no pulses are present at U11 pin 5 or 9. If the check voltages are near 0, and pulses are present, suspect U11. If the check voltages are not correct, suspect U10.

Now, return the input signal to 1600 Hz and sufficient amplitude to

light the LOCK LED. Monitoring U10 pin 12, increase the signal frequency and note that the voltage rises. Now, check U10 pin 14 and increase the signal frequency until the this voltage suddenly jumps toward +10. Verify that U11 pin 4 is likewise near +10 volts, then check for pulses at U11 pin 5. If there are none, suspect U11 or the associated circuitry.

Place an oscilloscope probe at U12 pin 2 or 3 and place switch S3 in the USB or LSB position. Pulses should appear. If no pulses appear, suspect U12, S3 or the associated parts and wiring.

Now, place the probe at U10 pin 8 and decrease the applied frequency until this voltage jumps towards +10 volts. Verify that U11 is outputting pulses at pin 9, then probe once more at U12 pin 2 or 3. With S3 in either the USB or LSB position, pulses should appear. If not, again suspect U12, S3 or the associated circuits.

If all is well to this point, connect the U12 emitters (pins 5 and 8) to ground via JMP5 and JMP6 and place a load resistor (10k or so) from the collectors (pins 6 and 7) to +5 volts.

With pulses present at U12 pin 2, move the probe to U12 pin 6. In either the USB or LSB position of S3, pulses should appear. If not, suspect U12. Next, place S3 in the opposite position and note that pulses are present at U12 pin 7.

If all is well, the digital AFC is functional. Recalibrate the digital AFC per the instructions in the section **INITIAL TESTING - NO TNC REQUIRED**. If the digital AFC still does not function with your radio, the problem is most likely in the he interwiring or the radio. Some radios, notably many ICOM products, have an unusual up/down circuit that may require mods to the PSK modem to render functional. Watch PSR for any reports or details of this kind.

NOTE: The MicroSats are in a low orbit. If your radio tunes in 10 Hz steps, you may want to change capacitors C32 and C34 from 10 uF to a value of 2.2 to 4.7 uF for faster tracking on high passes.

Voltages and Waveforms

The following tables may be of use in tracking down problems. They are broken down by circuit function. Power supply pins are not listed.

All waveforms are noted on the schematic.

POWER SUPPLY

DC Levels

	1 (in)	2 (gnd)	3 (out)
VR1	+13v	0v	+5v
VR2	+13v	+5v	+10v

MODULATOR

DC Levels

	4	6	8	10
U17	0v	0v	0v	0v
	5			
U24	+3.5v			

DEMODULATOR

The following measurements were made with the PSK modem in analog loopback, PSK mode with modulator clock at 1600 Hz, applied signal such that the 3rd LEVEL LED is illuminated, LOCK LED on.

DC Levels

	1*	1*	7	8		
U3	+5.5v	+4.5v	+5.25v	+5.25v		
	9	11				
U6	+5v	+3.3v				
	1	8	9	10		
U7	+5.25v	+5v	+5v	+5v		
	2*	3*	1*	2*	3*	
U8	+10v	+5v	+4.75v	0v	+5v	+5.25v
	12	13	14	12	13	14
U8	+5v	+5v	+5v	+5v	+5v	+5v

* Can be either set of values.

INDICATORS

DC Levels

U101	5*	5**	7	9***	9****
	0v	+0.18v	+1.26v	+3v	+10v

* No Input Signal
 ** 3rd LEVEL LED ON
 *** JP100 open
 **** JP100 shorted

U103	4	5*	6	7	9
	+1.6v	+5v	+8.3v	+1.25v	+3v

TUNE at center, 3rd LEVEL LED on

* Very high impedance here. 10Meg input Z DVM will load this down to about +4.55v

DIGITAL AFC

The following measurements were made with the PSK modem in analog loopback, PSK mode with modulator clock at 1600 Hz, applied signal such that the 3rd LEVEL LED is illuminated, LOCK LED on and the center TUNE LED illuminated.

DC Levels

	1	2	3	8	9	10
U10	0v	+9.4v	+5v	0v	+5v	+4.93v
	12	13	14			
U10	+5v	+5.23v	0v			
	1	2	3	4	5	6
U11	0v	0v	+3.3v	0v	0v	0v
	8	9	10	11	12	13
U11	0v	0v	0v	+3.3v	0v	0v

PAD FUNCTIONS

INTERFACE BOARD

Jumper JP200 should be shorted for TNC 1, open for TNC 2.

- 1 RXD (from TNC's FSK modem) to pin 1 of 8-pin DIN
- 2 ground to pin 2 of 8-pin DIN
- 3 x16 (TNC 2) or x32 (TNC 1) clock to pin 3 of 8-pin DIN
- 4 RXD (to HDLC controller) to pin 4 of 8-pin DIN
- 5 DCD (to HDLC controller) to pin 5 of 8-pin DIN
- 6 ground to pin 6 of 8-pin DIN
- 7 TXD (from HDLC controller) to pin 7 of 8-pin DIN
- 8 DCD (from TNC's FSK modem) to pin 8 of 8-pin DIN

NOTE: If you are planning on using a TNC 1 with this modem, pin 15 of the modem disconnect must be shorted to ground. It normally goes to ground via R79 (680 ohms).

DISPLAY BOARD

Jumper JP100 provides a moving line (shorted) or moving dot (open) (default) display for the LEVEL bar graph indicator.

- 1 +5 volts in from PSK Modem Main PC board
- 2 "TUNE" input from PSK Modem Main board PAD 14
- 3 digital "DCD" input from PSK Modem Main board PAD 12
- 4 +10 volts in from PSK Modem Main board
- 5 Ground from PSK Modem Main board
- 6 "LEVEL" input from PSK Modem Main board PAD 19

MAIN BOARD

- 1 1600 Hz sq wave output to PAD 4 for "PSK" mode xmit
- 2 1200 Hz sq wave output to PAD 4 for JAS mode with TNC 1
- 3 1200 Hz sq wave output to PAD 4 for JAS mode with TNC 2
- 4 clock input for mixing with xmit data for PSK/JAS xmit
- 5 xmit audio out from PSK modem to pad 8 in PSK modes
- 6 +12 volts unregulated input
- 7 xmit audio out from TNC to pad 8 in FSK mode
- 8 xmit audio out to VHF radio
- 9 rcve audio to front panel pot
- 10 rcve audio from front panel pot
- 11 digital RXD from PSK modem to PAD 17 in PSK modes
- 12 DCD from PSK modem (to display board)
- 13 DCD from PSK modem to PAD 15 in PSK modes
- 14 filtered "tune" signal (to display board)
- 15 DCD to TNC modem disconnect
- 16 DCD from TNC internal modem to PAD 15 in FSK mode
- 17 digital RXD to TNC modem disconnect
- 18 RXD from TNC internal modem to PAD 17 in FSK mode
- 19 "level" output (to display board)
- 20 Ground return (power in)
- 21 AFC step down pulse from AFC logic
- 22 AFC step down pulse to optocoupler
- 23 AFC step up pulse from AFC logic
- 24 AFC step up pulse to optocoupler

Test Points

TP1 is the test point for eye patterns.

TP2 is the 4046 vco output for setting R33 to 12.8 kHz.

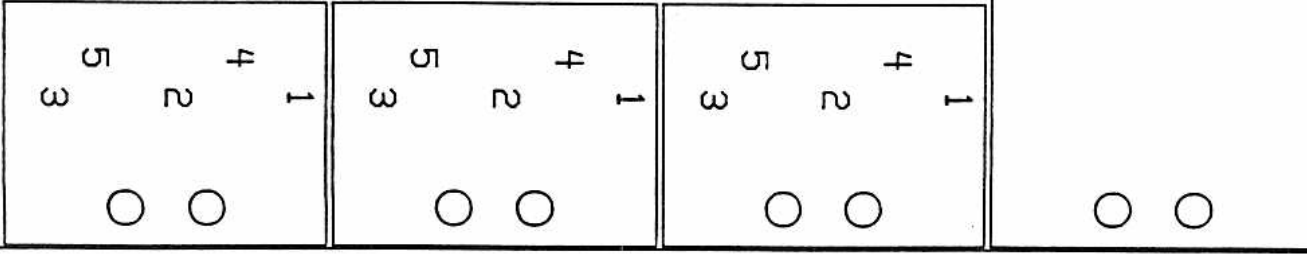
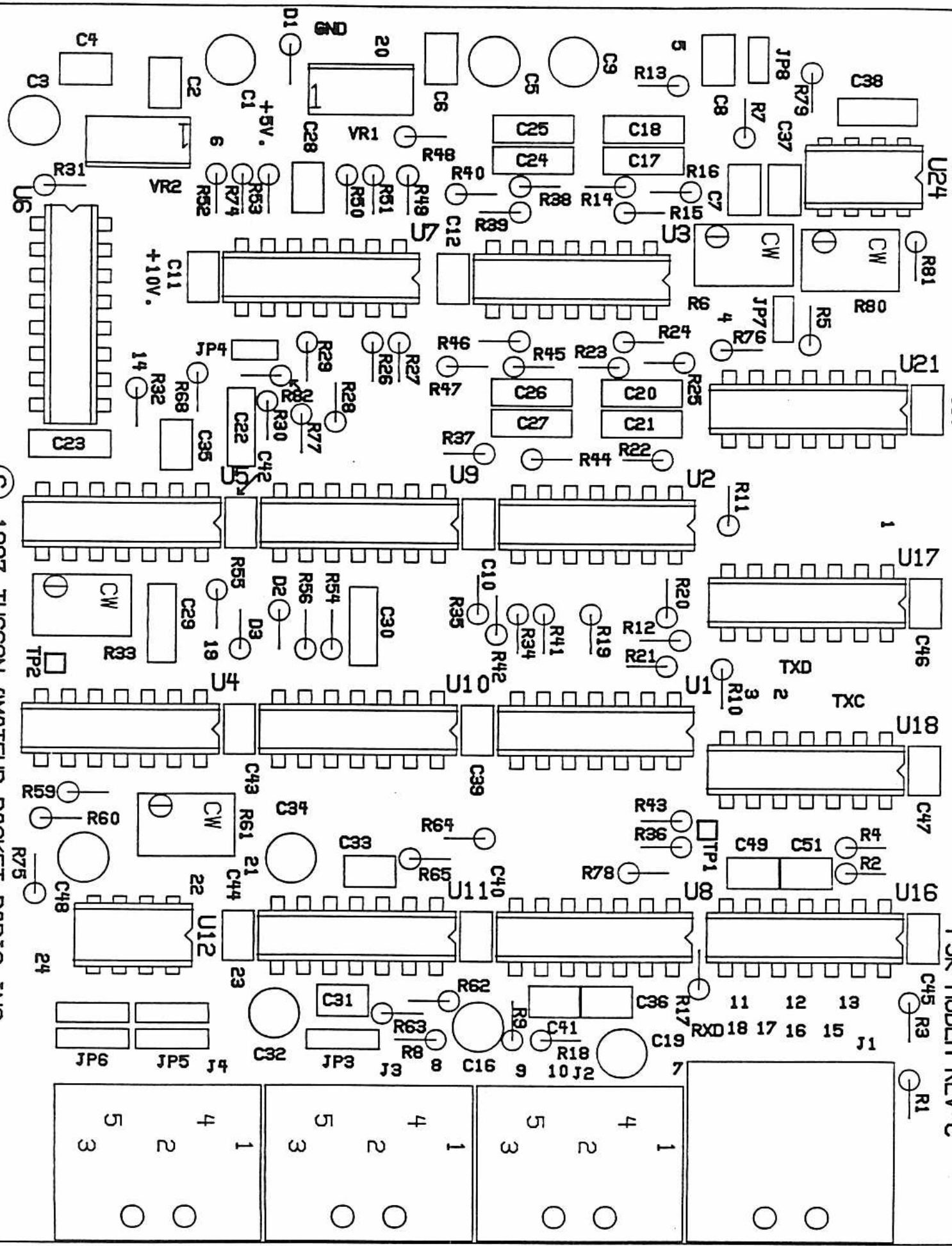

1 2 3 4 5 6 7 8

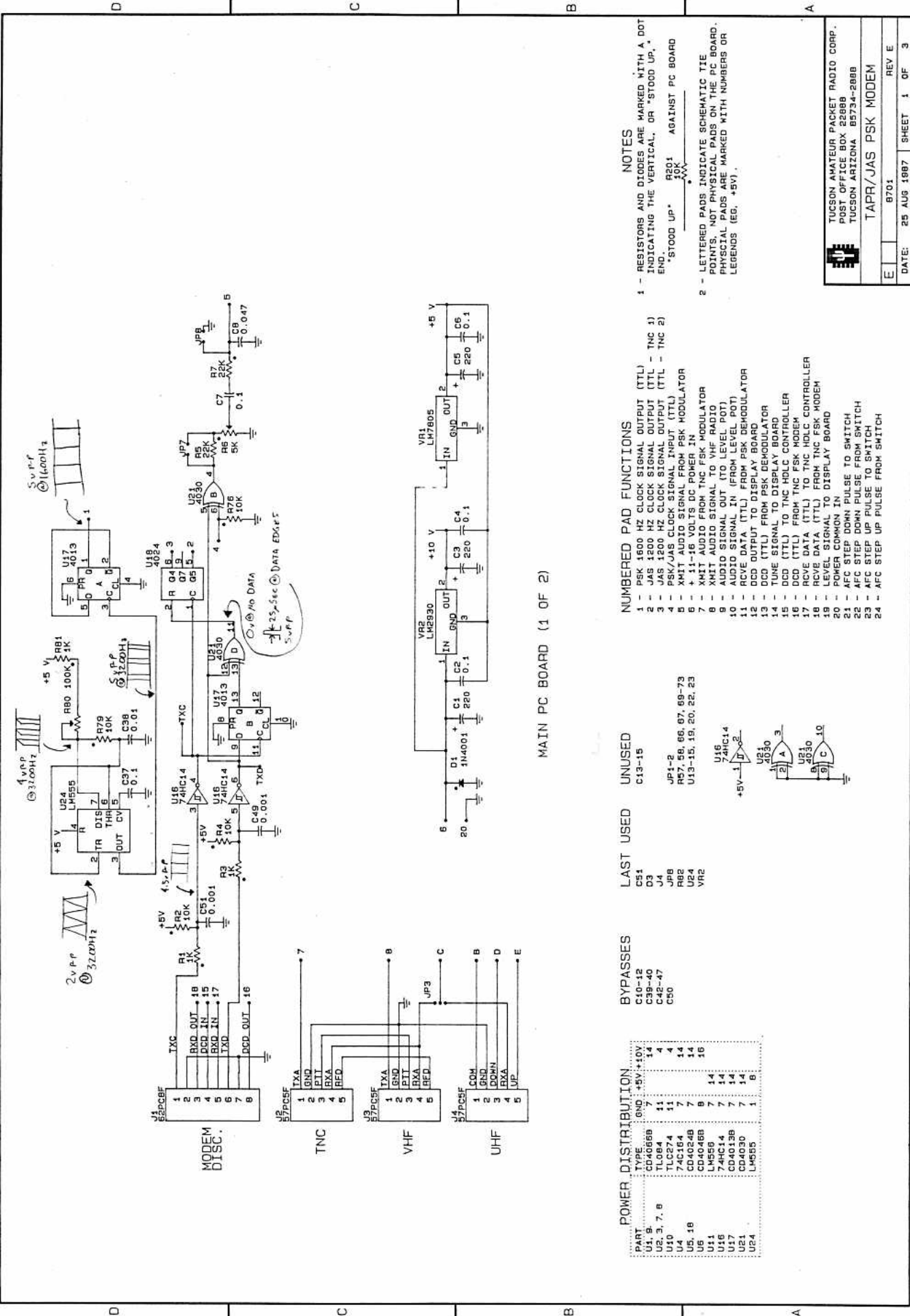

MAIN PC BOARD (1 OF 2)

TUCSON AMATEUR PACKET RADIO CORP.
POST OFFICE BOX 22888
TUCSON ARIZONA 85734-2888
TAPR/JAS PSK MODEM
8701
DATE: 25 AUG 1987 SHEET 1 OF 3
REV E

1 2 3 4 5 6 7 8

WAVEFORMS ASSUME: LOOPBACK
 PSK @ 1600 Hz
 3 LED LEVEL
 LOCK-ON
 TUNE CENTER

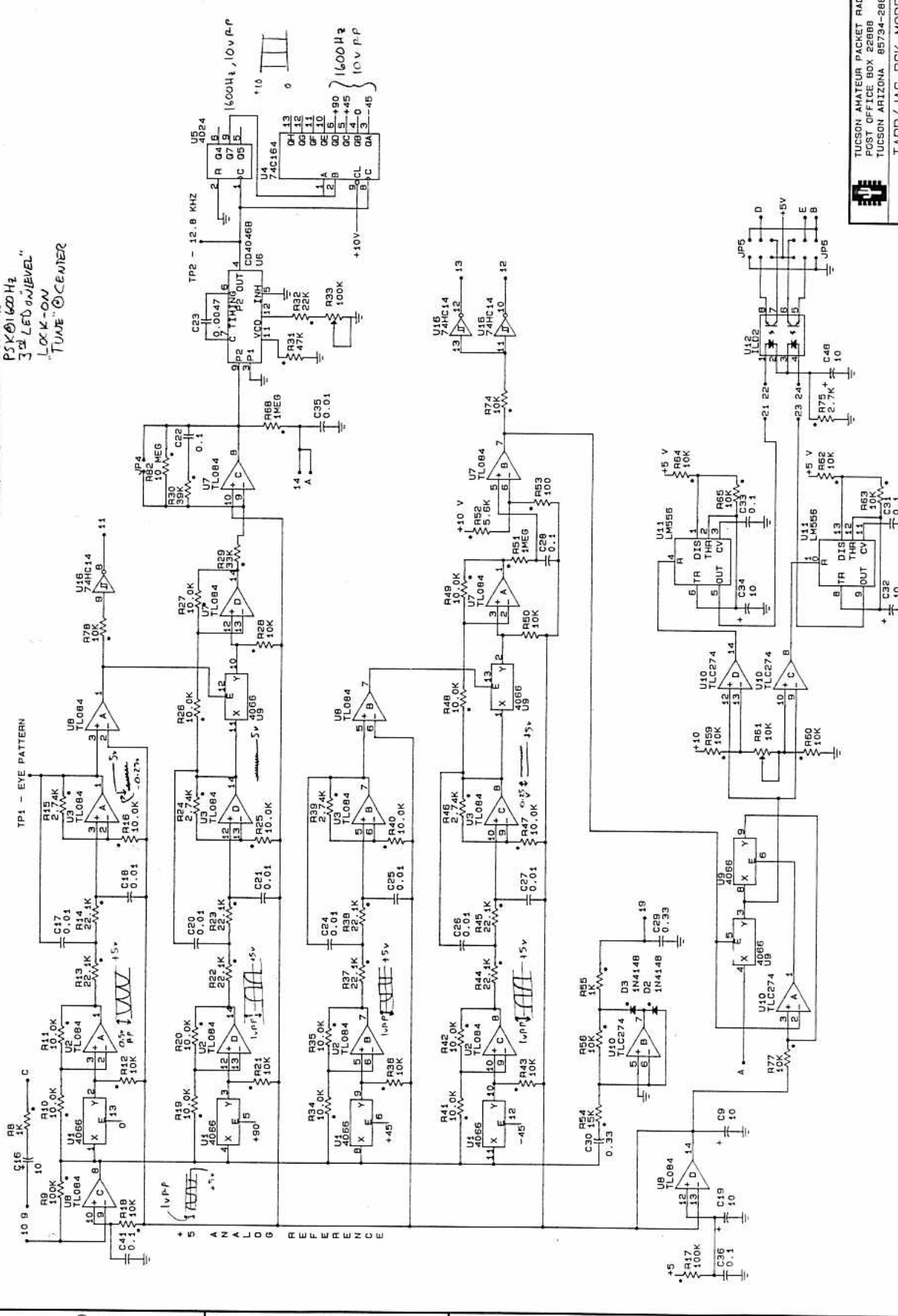

TUCSON AMATEUR PACKET RADIO CORP.
 POST OFFICE BOX 2888
 TUCSON ARIZONA 85734-2888

TAPR/JAS PSK MODEM

DATE: 25 AUG 1987 SHEET 2 OF 3

8701 REV E

MAIN PC BOARD (2 OF 2)

1 2 3 4 5 6 7 8

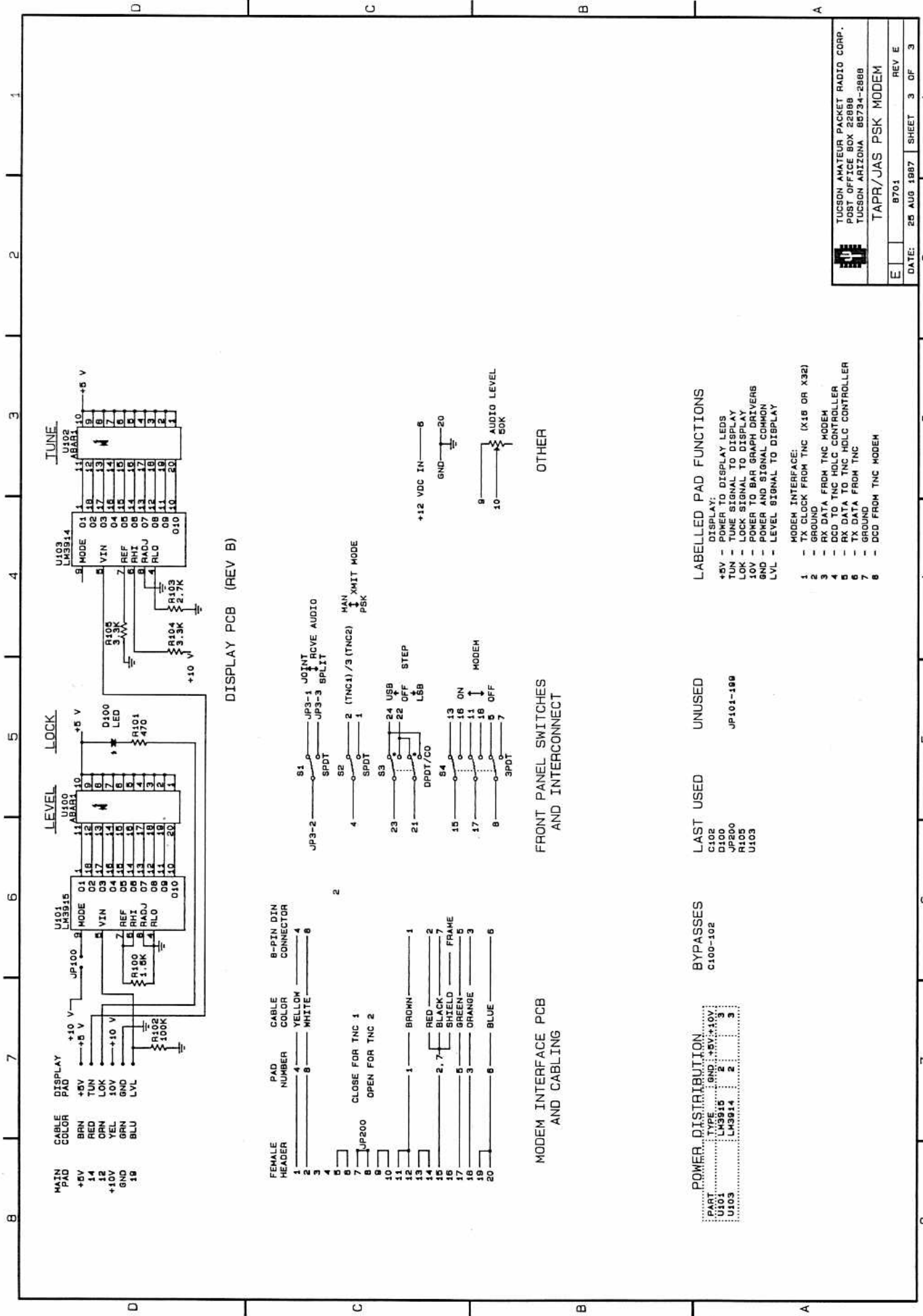

DISPLAY PCB (REV B)

FEMALE HEADER	PAD NUMBER	CABLE COLOR	B-PIN DIN CONNECTOR
1	4	YELLOW	4
2	8	WHITE	6
3			
4			
5			
6			
7	JP200		
8			
9			
10			
11			
12			
13			
14			
15			
16			
17			
18			
19			
20			

MODEM INTERFACE PCB AND CABLING

FRONT PANEL SWITCHES AND INTERCONNECT

OTHER

POWER DISTRIBUTION

PART	TYPE	VAL	END	START
U101	LM3915	2	+5V	+10V
U103	LM3914	2		3

BY-PASSES
C:100-102

LAST USED
C:102
D:100
JP:200
R:105
U:103

UNUSED
JP:101-100

LABELLED PAD FUNCTIONS
 DISPLAY:
 +5V - POWER TO DISPLAY LEADS
 TUN - TUNE SIGNAL TO DISPLAY
 LOK - LOCK SIGNAL TO DISPLAY
 10V - POWER TO BAR GRAPH DRIVERS
 GND - POWER AND SIGNAL COMMON
 LVL - LEVEL SIGNAL TO DISPLAY

MODEM INTERFACE:
 1 - TX CLOCK FROM TNC (X18 OR X32)
 2 - GROUND
 3 - RX DATA FROM TNC MODEM
 4 - DCD TO TNC HOLD CONTROLLER
 5 - RX DATA TO TNC HOLD CONTROLLER
 6 - TX DATA FROM TNC
 7 - GROUND
 8 - DCD FROM TNC MODEM